



AUDIO/VIDEO EQUIPMENT

COMPLETE TRANSPORTATION ENTERTAINMENT SOLUTIONS

2016

Media Players
DVD Players
Radios
Monitors
PAs
Speakers
Antennas
Microphones
Wi-Fi



REI

Fully integrated solutions from a ONE-SOURCE leader.

Delivering on the strength of a 75-year history, Radio Engineering Industries (REI), a family-owned company, continues to be the longstanding innovator, manufacturer and supply chain provider to the transportation market. With industrial quality products designed and engineered in the USA, the foundation of excellence lies in equipping your transportation vehicles with the ultimate customer experience.

From a basic cable to a fully loaded entertainment system, REI is your one-source provider streamlining your process to keep your information and entertainment systems performing.

REI is recognized for premier engineering and manufacturing and our expertise has sustained an ever-changing marketplace, providing custom engineering and service parts for almost any need.

Information is a necessity and entertainment is satisfaction. REI is essential. Family values. Customer care 24/7/365. Paramount to drive industry excellence.

Engage in the experience.

enhance the rider experience:



Why REI is Superior

- One-source provider for engineered products and solutions.
- Over 75 years of industry knowledge leading the mobile market.
- Products designed, engineered and developed in the USA.
- Flexible and expandable entertainment solutions complement your vehicles with industry excellence.
- We'll never leave you stranded with 24/7/365 customer support.



inform. entertain. all access.

contents



p. **8**
MegaMedia



p. **24**
PA Systems



p. **10**
Radios with
DVD Players



p. **26**
Dynamic
Microphones/Cables



p. **12**
Radios



p. **31**
Carbon
Microphones/Cables



p. **16**
Radio Harnesses



p. **32**
Gooseneck
Microphones



p. **22**
Radio Accessories



p. **34**
Wireless
Microphones



p. **23**
Radio Mount Kits



p. **36**
EC-750 Driver Control
Module/Radio



p. **38**
Video/Multi-Media
Sources



p. **50**
Passenger Safety
Announcement Player



p. **40**
LCD Monitors



p. **52**
Speakers

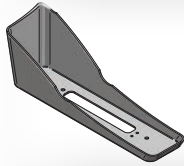

p. **43**
LCD Trim Kits



p. **58**
Antennas



p. **44**
HDMI E
Modules/Cables



p. **61**
Mobile Cellular
Wi-Fi Routers



p. **46**
HDMI
Cables/Connectors



p. **62**
Individual Passenger
Seat Back Audio

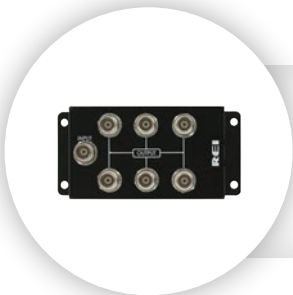

p. **48**
Video Distribution
Amplifiers & Cables



p. **66**
Video System
Service Parts

your foundation to HD theater entertainment

Provide passengers and drivers with an advanced entertainment environment that enhances their time in transit. Let REI provide you with feature-rich products that deliver the ideal experience.

HD READY

EASY OPERATION

DRIVER/PASSENGER ZONE

EC-750 Driver Control Module

710467



ECD-5500 Radio

710473



enhance. customize.

From state-of-the-art video systems and multi-media radios, to countless accessories, the foundation of outstanding on-board entertainment starts with REI.

PROGRAMMABLE

EXPANDABLE

BLUETOOTH FRIENDLY

EC-750 Driver Control Module

710467



Touchscreen Convenience

Enhanced LCD Display

DVD Included

Accessories Available



EVR-6500D Multi-Media Radio

710464



invigorate.

See pages 36-37 for more information on the EC-750 Driver Control Modules and Radios.



REI is proud to introduce MegaMedia™, our new state-of-the-art wireless on-demand passenger entertainment system designed for use on all modes of transportation including trains and buses. Enhance your passengers' on-board experience by providing amazing high definition movie and TV content streamed wirelessly to your passengers' personal devices like smartphones, tablets and computers. Travelers can simply log on to your passenger entertainment portal and enjoy your content libraries while traveling in the comfort of their own seat.



Passengers can gain access to movies and television via Wi-Fi through REI's Digital Media Center.

HOW IT WORKS



1

Download the MegaMedia app to your smartphone, tablet or laptop.

2

Select desired content from a list of movies and television programs.

3

Select "play now" and enjoy the show.

luxury entertainment placed
in your passengers' hands



System Requirements

- License agreement for movies required.
- Wi-Fi connection required.

DESCRIPTION	PART #
Digital Media Center	Contact REI

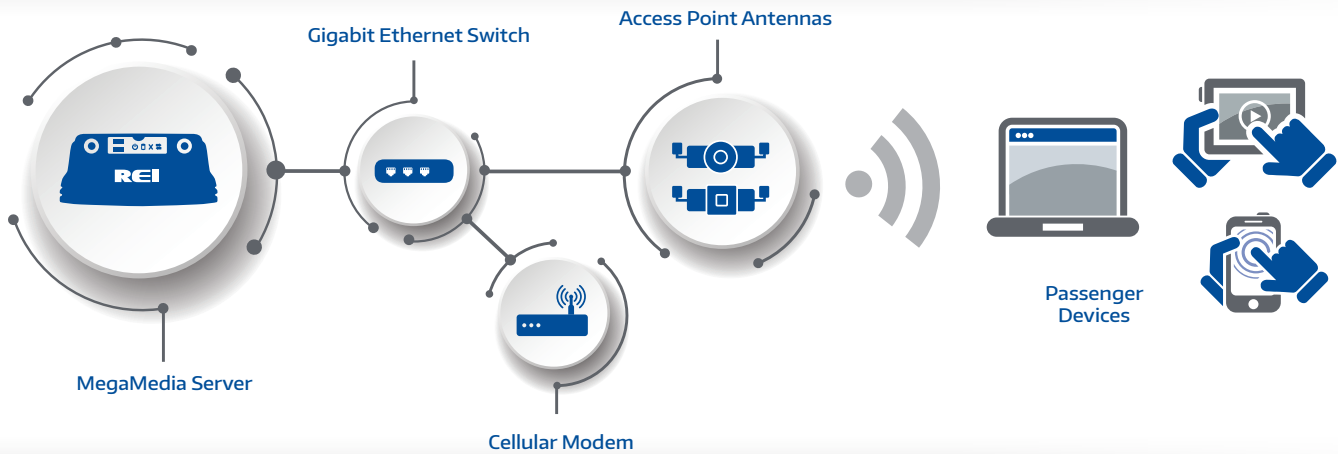

Features

- Wi-Fi content streaming
- HD Digital Media playback
- Input voltage range 8-32 volts
- Ruggedized construction
- Military grade components
- Super speed USB 3.0 interface
- Intel® Quad-Core processor
- Solid state drives
- Gigabit Ethernet
- Wireless 802.11 ac

Some of the studios featured include:



radios with DVD players

VR-6000D Multi-Media Radio

Enjoy your music and video collection from a stunning 6.2" touch screen in every popular format, including CD, DVD, MP3, WMA, MPEG-1, MPEG-2, MPEG-4, and AVI. The multi-media system works with Bluetooth®- enabled devices. This capability combined with the head unit's integrated microphone and your vehicle's speaker system allows for easy, safe and hands-free operation of cellular phones or playing music from connected devices.

FEATURES

- Preset up to 30 radio stations (18 FM, 12 AM)
- 6.2" touch screen
- Displays ID3 tag information
- Bluetooth® audio streaming and hands-free calling
- USB (type A & mini-B)/MicroSD input
- Rear view camera input
- iPod® playback control
- CD/DVD player
- PA (optional)

VR-6000D

ITEM	PART #
VR-6000D w/Bare Wires	710497

VR-6000D w/PA

ITEM	PART #
VR-6000D w/PA (Includes 2 Dynamic Mic Inputs)	710524

System Includes:

Dynamic Microphone	480015
36" Microphone Cable	512159



VR-6000D Accessories

Camera Observation System



ITEM	PART #
Camera w/Motorized Lens Cover, 2.9mm	710343
18' Adapter Cable - 5 Pin Din to RCA Video and Power Wires	512666
65' Camera Cable	512369
33' Camera Cable	512401
15' Camera Cable	512400

Dashmount USB Audio Input

ITEM	PART #
10" USB Weather Resistant Panel Mount w/Cover to Male USB Connector	512485

GPS Mapping

ITEM	PART #
GPS Antenna	710469
GPS Mapping	Contact REI

VR-3000 Multi-Media Radio

The VR-3000 is our premiere single DIN multi-media receiver that includes an integrated public address (PA) amplifier system and dedicated video outputs for connecting monitors for passengers. During PA announcements, REI's advanced override technology prevents customers from missing content by pausing the audio/video media. This system also offers front SD Card - USB and 3.5 mm AUX inputs allowing you to enjoy music from your external media devices.



FEATURES

VR-3000

ITEM	PART #
VR-3000 w/Bare Wires	710248
VR-3000 w/Tri-Amp Plugs	710386
VR-3000 w/Thor Plug	710302
VR-3000 w/Thomas/Arboc Plug	710326

- AM/FM stereo receiver
- Commercial grade anti-shock DVD/CD player
- Plays MP3, MPG, WMA, ACC, JPEG file formats
- Displays ID3 tag information
- USA/EURO radio frequency modes
- Stations stored during power loss
- Radio station lock out feature
- Front panel USB, SD, 3.5mm auxiliary inputs
- Public address (PA) amplifier – 2 dynamic/1 carbon input
- Auxiliary A/V inputs (RCA)
- Video (BNC) and Audio (RCA) outputs
- 50W x 4 power output
- Remote control

radios

REI radios are engineered in the USA utilizing uncompromising commercial grade components and top quality materials. Developed specifically for the rigors of commercial vehicle applications, our radios provide excellent performance for use in environments subject to vibration, dynamic loads, high temperatures and humidity. REI further tests the radio's life and durability by conducting life and stress tests that simulate years of rugged use under harsh conditions. Dependable experience and keeping a close eye on the future have made us the market leaders in commercial electronics. Experience, reliability, innovation and quality – our ingredients in a recipe designed to guarantee your satisfaction.

CD-3000

AM/FM/CD Stereo Radio with PA



ITEM	PART #
CD-3000 w/Bare Wires	710430
CD-3000 in Universal Housing w/Integrated Speakers	760936
CD-3000 w/Thor Harness (512443)	710531
CD-3000 w/Thomas/Arboc Plug	710543

CD-5000

AM/FM/CD/BT Stereo Radio with PA



ITEM	PART #
CD-5000 w/o Harness	710437
CD-5000 Elite & Advanced System	710493
CD-5000 - System 2000	710496
10" USB Weather Resistant Panel Mount w/Cover to Male USB Connector	512485

ST-4000

AM/FM/WB Stereo Radio with PA



ITEM	PART #
ST-4000 w/o Harness	710357
ST-4000 w/Bare Wires	710295
ST-4000 w/Dynamic HH Mic (480015) and 3' Mic Cable (512159)	760924
ST-4000 w/Thor Plug	710313
ST-4000 w/Thomas/Arboc Plug	710328
ST-4000 w/Nova Plug	710443

ST-3000

AM/FM/WB Stereo Radio with PA



AUX WB

ITEM	PART #
ST-3000 w/o Harness	710374
ST-3000 w/Bare Wires	710453

AW-10

AM/FM Stereo Radio



MP3 WMA USB AUX BT

ITEM	PART #
AW-10 w/Bare Wires	710461
AW-10 w/Delphi Packard Connector	710495
AW-10 Universal Mount Bracket	561086

ST-1000

AM/FM/WB Stereo Radio



AUX WB

- Shallow chassis with 2.75" mounting depth

ITEM	PART #
ST-1000 w/ISO Connector	701193
ST-1000 w/Kalmar Plug (512724)	760940

Radio Kit



- ST-1000 AM/FM weatherband stereo radio
- Black ABS plastic radio and speaker housing
- (2) 5" full-range speakers (220035)
- Flexible AM/FM antenna w/60" cable (210066)

ITEM	PART #
ST-1000 Mounted in Black ABS Radio/ Speaker Housing w/Integrated Speakers and 1/4" Headphone Jack	760910

RADIO COMPARISON



VR-6000

VR-3000

CD-5000

	DVD	✓	✓	
	Compact disc w/anti-skip mechanism	✓	✓	✓
	MP3/WMA playback	✓	✓	✓
	Front-panel SD/SDHC card input	✓ (uSD)	✓	
	USB			
	Front-panel type-A input	✓ (mini-B)	✓	
	Rear type-A input	✓	✓	✓
	Cellphone charge port in USB mode	low current devices only	low current devices only	✓
	Bluetooth®			
	Audio streaming	✓		✓
	Hands-free calling	✓		✓
	iPod®/iPhone® ¹			
	Built-in iPod charging	✓		✓
	Built-in iPhone charging	✓		✓
	Built-in iPod controls	✓		✓
	AUX			
	Front panel connects iPods, MP3 players and portable media players		✓	✓
	Rear / RCA audio input jack	✓	✓	✓
	PA			
	Integrated PA	✓	✓	✓
	Dynamic microphone PA inputs	2	2	Selectable Menu-1 (4 Pin)
	Carbon microphone PA inputs		1 (3 Pin)	Selectable Menu-1 (4 Pin)
	PA triggered digital media pause		✓	
	Adjustable PA zone output (front/rear/both)		✓	✓
	AAC		✓	
	WB (Weather Band)			✓
	Radio chassis connector	16 Pin Type "B"	16 Pin	ISO
	Preset stations	18 FM / 12 AM	18 FM / 12 AM	18 FM / 12 AM 7 WB
	Power rating	50 Watt x 4	50 Watt x 4	50 Watt x 4
	USA/EURO radio frequency modes	✓	✓	✓
	Radio station lock out			
	Station presets stored during power loss		✓	✓
	Clock	✓	✓	✓
	30 day clock backup			✓
	RDS text ²		✓	

¹ Earlier model iPods are not supported because they do not implement the USB control protocol. They may be connected to the radio using auxiliary inputs if available.

² Radio stations broadcasting RDS may not be available in your listening area.



CD-3000

ST-4000

ST-3000

ST-1000

AW-10

✓				
✓	✓			✓
✓	✓			
✓	✓			
low current devices only	low current devices only			low current devices only
				✓
✓	✓	✓	✓	
✓	✓	✓		✓
✓	✓	✓		
2	2	Selectable Menu-1 (4 Pin)		
1 (3 Pin)	1 (3 Pin)	Selectable Menu-1 (4 Pin)		
✓				
✓	✓	✓		
✓	✓	✓	✓	
16 Pin	16 Pin	ISO	ISO	NA (Hard Wire)
18 FM / 12 AM 7 WB	18 FM / 12 AM 7 WB	18 FM / 12 AM 7 WB	18 FM / 12 AM 7 WB	18 FM / 12 AM
50 Watt x 4	50 Watt x 4	50 Watt x 4	50 Watt x 2	40 Watt x 4
✓	✓	✓	✓	✓
✓	✓			
✓	✓	✓	✓	✓
✓	✓	✓	✓	✓
		✓		
✓				

radio harnesses

VEHICLE	VEHICLE CONNECTOR (For details, see pgs. 18-21)	VR-6000D	VR-3000	CD-5000
Generic	Bare Wires			√
	Bare Wires			√
	N/A		√	
	Bare Wires			
	Bare Wires		√	
	Bare Wires	√		
Arboc / Thomas	16 Pin Male Mini-Fit™		√	
Ford 2003-2010	70-5520			√
Ford 1998 & up	70-1771			√
Ford 1985-2004	70-1770			√
Freightliner 1986-2004	BT-147			√
GM 2006 & up	70-2105			√
GM 1998-2008	70-2003			√
GM 1987-2005	70-1858			√
GM 2000 & up	GMOS-01 (Kit)			
International / Navistar 1992-2004	BT-128			√
Kalmar	Packard - (1) REI #111014 and (1) 3 Pin REI #111015			√
Motor Coach Industries 2014 & up	(1)12 Pin Deutsch Connector & (3) 2 Pin Mini-Fit™ Molex			√
	(1) 6 Pin Molex, (1) 4 Pin Mini-Fit™ Molex, (1) 2 Pin Mini-Fit™ Molex			√
Motor Coach Industries 1982-1992 Tri-Amp, 102, MC96, MC9, MC8, MC7	12 Pin Female Molex		√	
New Flyer	Packard - (1) 4 Pin, (1) 3 Pin, and (2) 2 Pin			√
	Packard - (1) 4 Pin, (1) 3 Pin and (2) 2 Pin			
Nova Bus	Packard - (2) 4 Pin and (1) 3 Pin			
Peterbilt/Kenworth 1986 & up	BT-169			√
Thor	12 Pin Male Molex			
	12 Pin Male Molex		√	
	12 Pin Male Molex	√		

CD-3000	ST-4000	ST-3000	ST-1000	PART #	DETAILS
		√	√	512202	
		√	√	512203	Includes In-line Filter
√	√			512441	Harness Converts Radio with Mini-Fit™ to ISO Plug so other ISO Harnesses can be used
√	√			512439	No Video Trigger Wire - Do Not Use with Video Radios
√	√			512382	Includes Video Trigger Wire
				512728	
√	√			512449	Includes Video/Amplifier Trigger (for use w/VR-3000)
		√	√	512295	
		√	√	512201	
		√	√	512261	
		√	√	512329	
		√	√	512308	
		√	√	512307	
		√	√	512306	
				512596	Interface allowing OEM radio to be replaced with aftermarket radio in non-amplified GM vehicles retain functionality of OnStar® and chimes. Must purchase generic REI radio harness separately.
		√	√	512330	
		√	√	512724	
		√	√	512676	9' D40 ISTV Coach Radio w/o EC-750 Control Head
		√	√	512653	23' D Commuter Coach Radio w/o EC-750 Control Head
√	√			512475 and 512476	Includes Video Trigger Wire
		√	√	512328	
√	√			512445	No Video Trigger Wire - Do Not Use with Video Radios
√	√			512505	No Video Trigger Wire - Do Not Use with Video Radios
		√	√	512331	
√	√			512443	No Video Trigger Wire - Do Not Use with Video Radios
√	√			512428	Includes Video/Amp Trigger (for use w/VR-3000)
				512729	

radio harnesses

FORD 70-5520

REF: 70-5520/AW-WHFD4/CF-WHFD4



- Main power harness with 4 speaker connections
- One 24 pin plug

Applications

- FORD Econoline (a.k.a. E-Class) 2009 2010
- F-250/350/450/550 2008 2010
- F-250/350/450/550 2005 2007
- FORD F-150 XL (w/o plus pkg) 2009 2010
- FORD F-150 2007 2008
- FORD F-150 2004 2006
- FORD Five Hundred 2005 2007

FORD 70-1770

REF: 70-1770/AW-WHFD2/CF-WHFD2/CK-WHFD2



- Power 4 speaker

Applications

- FORD Econoline Full Size Van 1997 1997
- FORD Econoline Full Size Van 1992 1996
- FORD Econoline Full Size Van 1986 1991
- FORD F-150 1997 1998
- FORD F-250/350/450/550/650/750 1997 1998
- FORD F-Series Pickup 1992 1996
- FORD F-Series Pickup 1987 1991
- FORD F-Series Pickup 1986 1986

FORD 70-1771

REF: 70-1771/AW-WHFD3/CF-WHFD3



- Power 4 speaker

Applications

- FORD Econoline Full Size Van 1998 2008
- FORD Excursion 2000 2005
- FORD F-150 Classic 2004 2004
- FORD F-150 1999 2003
- FORD F-650 2005 2008
- FORD F-250/350/450/550/650/750 1999 2004

Freightliner BT-147



- All med duty radio overhead
- COE models built after 6/86 thru 7/04
- Conventional models built after June 1988 thru 7/04

GM 70-2105



- Does not retain any warning chimes and OnStar
- No 12 volt accessory output

GM 70-2003

REF: 70-2003/AT-WHGM3/AW-WHGM3/CF-WHGM3



- Power 4 speaker

Applications

- CHEVROLET Express van (full size) 2001 2002
- CHEVROLET Van (full size) Express 2001 2002
- GMC Savana Full Size Van 2001 2002

GM 70-1858

REF: 70-1858/AW-WHGM2/CF-WHGM2/CK-WHGM2



Applications

- CHEVROLET Astro Van 1996 2005
- CHEVROLET Astro Van 1991 1995
- CHEVROLET Express van (full size) 1996 2000
- CHEVROLET Suburban 2000 2002
- CHEVROLET Suburban 1995 1999
- CHEVROLET Suburban 1992 1994
- CHEVROLET Van (Full Size) Express 1996 2000
- CHEVROLET Van (Full Size) 1988 1995
- CHEVROLET Venture Van 1997 1999
- GMC Sierra 1999 2002
- GMC Sierra 1995 1998
- GMC Sierra 1988 1994
- GMC Savana Full Size Van 1996 2000
- GMC Suburban 1995 1999
- GMC Suburban 1992 1994
- GMC Van (Full Size) 1988 1995

radio harnesses

GMOS-01

HIGH LEVEL INPUT NON-BOSE/PREMIUM



The GMOS-01 interface is designed to allow the user to replace the OEM radio with an aftermarket unit in non-amplified GM vehicles and retain full functionality of the OnStar® system as well as all safety and warning chimes. The GMOS-01 will also retain the retained accessory power convenience features. This interface has the capability of adjusting chime and OnStar® volumes as well. In addition to these features, the GMOS-01 now has the required outputs for the installation of a navigation radio.

- USB update interface compatible
- For non-amplified audio systems
- Retains OnStar® w/adjustable volume output
- Retains chime w/adjustable volume output
- Retains RAP feature
- Navigation outputs now included

Applications

- BUICK Allure 2005-2009
- BUICK Century 2004-2005
- BUICK LaCrosse 2005-2009
- BUICK Rainer 2004-2007
- BUICK Rendezvous 2002-2007
- BUICK Terraza 2005-2008
- CADILLAC Escalade 2003-2006
- CADILLAC Escalade EXT 2003-2006
- CHEVROLET Avalanche 2003-2006
- CHEVROLET Cavalier 2000-2005
- CHEVROLET Colorado 2004-up
- CHEVROLET Corvette 2005-up
- CHEVROLET Express 2003-2007
- CHEVROLET Impala 2000-2005
- CHEVROLET Malibu 2000-2003
- CHEVROLET Malibu Classic 2004
- CHEVROLET Monte Carlo 2000-2005
- CHEVROLET Silverado 2003-2006
- CHEVROLET Silverado Classic 2007 SSR 2003-2006
- CHEVROLET Suburban 2003-2006
- CHEVROLET Tahoe 2003-2006
- CHEVROLET Trailblazer 2002-2009
- CHEVROLET Uplander 2005-2008
- CHEVROLET Venture 2000-2005
- GMC Canyon 2004-up
- GMC Envoy 2002-2009
- GMC Savana 2003-2007
- GMC Sierra 2003-2006
- GMC Sierra Classic 2007
- GMC Yukon/XL/Denali 2003-2006
- HUMMER H2 2003-2007
- HUMMER H3 2006-2009
- ISUZU Ascender 2003-2008
- ISUZU I-Series 2006-2008
- OLDSMOBILE Alero 2001-2004
- OLDSMOBILE Bravada 2002-2005
- OLDSMOBILE Intrigue 2002
- OLDSMOBILE Silhouette 2000-2004
- PONTIAC Aztec 2001-2005
- PONTIAC Grand Am 2001-2005
- PONTIAC Grand Prix 2004-2008
- PONTIAC Montana 2000-2005
- PONTIAC Sunfire 2000-2005
- SAAB 9-7x 2005-2009
- SATURN Relay 2005-2007

International/Navistar BT-128

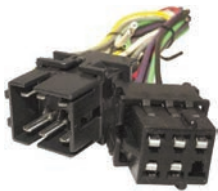

- 2800-8300 series med duty built 7/92 to 8/04
- 9000 series conventional built 7/92 to 8/04
- 9000 series conventional pro sleeper from 7/94 to 8/04

Motor Coach Industries Harnesses



(2) 12 Pin Deutsch Connector &
(3) 2 Pin Mini-Fit™ Molex



(1) 6 Pin Molex, (1) 4 Pin Mini-Fit™
Molex, (1) 2 Pin Mini-Fit™ Molex



12 Pin Female Molex

New Flyer Harnesses



Packard - (1) 4 Pin, (1) 3 Pin, and (2) 2 Pin

Thor Harnesses

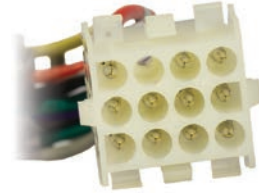

Nova Bus Harnesses



Packard - (2) 4 Pin and (1) 3 Pin

Radio Chassis Connectors

ISO

CD-5000/ST-3000/ST-1000



16 Pin Mini-Fit™

VR-3000/CD-3000/ST-4000



16 Pin Mini-Fit™ Type B

VR-6000D



Note: Wiring Pinout Different

Peterbilt/Kenworth BT-169



- All medium duty COE and conventional (330)
- COE models built after 10/86
- Conventional models built 10/86 to 6/05

radio accessories

Filters & Chokes



450010

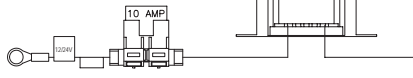

510996

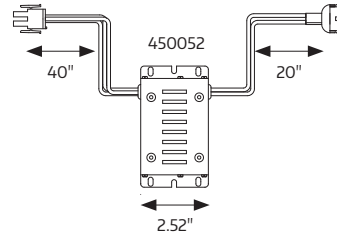

450052

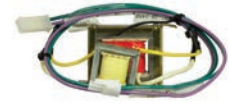

451014

ITEM	PART #
10 AMP Alternator Noise Suppressor 12/24V	450010
10' Power Cable w/10 Amp Fuse and 10 Amp Filter (450010) 12/24V	510996
10 AMP Power Filter - 12/24V with 2 Pin Male MATE-N-LOK to 2 Pin Female MATE-N-LOK	450052
3' Radio Power Filter Harness w/10 AMP Constant - Hot and 3 AMP Ignition Alternator Noise Suppressors - 12/24V 2 Pin Female Mini-Fit™ to 2 Pin Male Mini-Fit™	451014

Audio Isolation Transformers



ITEM	PART #
12" Inline Audio Isolator Dual RCA Male to Dual RCA Female	461003
12" Inline 10K Audio Ground Loop Isolator - 4 Pin Male Mini-Fit™ to 4 Pin Female Mini-Fit™	512652
18" Inline Audio Isolator Dual RCA Female to Dual RCA Male	461008

Amplifier

Line Audio Pre-Amp w/RCA



ITEM	PART #
Amplifier - Line Audio Pre-Amp w/RCA	700913

Solenoids



ITEM	PART #
Contactor - 24V	300020
Contactor - 12V	300021

Audio Amplifier - 12V



- 300W Peak Power - 150W x 2
- High/Low level audio input
- Input level control
- Fused and thermal protection
- Reverser polarity protection

ITEM	PART #
2 Channel - 12V	710488

radio mount kits

Universal Radio Mount Kits

550344



• Din or 2-Shaft

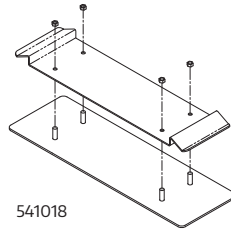

541018



750297 – front
(Radios not included)



750297 – side



551062 – 21.5"L x 8.75"W x 2.9"H

ITEM

Universal Radio Housing

PART

550344

Din Radio Filler Panel Kit

541018

Universal Radio Housing w/2 Separate Din Openings

750297

Din Radio Housing w/out Speaker Cut Outs

551062

Radio Mount Kits



VEHICLE	MODEL	MAKE	YEAR	PART #
Universal	99-9000	Universal	Universal	550344
Chevy Full-Size Van	99-4500	GM/Chevrolet	1988-1995	550766
Chevy/GMC Older Trucks	99-3000	GMC/Chevrolet	1988-1994	550902
Chevy/GMC Older Trucks	88-00-3301	Chevrolet	1988-1994	550915
Chevy Express Van with CD Pocket	99-2003	Chevrolet	2001-2007	550916
Chevy Express Van	99-2001	Chevrolet	2001-2007	560688
	99-3002	Chevrolet	1996-2000	560955
	99-3305	GM	2008-2014	550917
Econoline	99-5600	Ford	1997	560476
	99-5802	Ford	1998-2008	560912
	99-5812	Ford	2009-2014	560947
	99-5700	Ford	1975-1996	560958
Savana/Express	99-3301	Chevrolet	2003-2006	560960
Dodge Van	99-6700	Dodge	1978-2003	560956
Sprinter	99-6509	Dodge	2003-2006	560959
	99-6512	Dodge	2007-2008	560957
UHaul Complete Kit	99-3000			750234
	99-2003			750235
	99-3305			750236
	99-5802			560912

PA systems

1 and 2 Channel PA Amplifiers



Front View

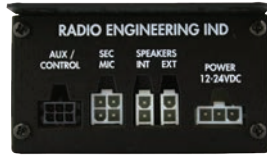

Back View

- 2 microphone inputs
- 50 Watt power output
- XLR priority microphone input overrides Mini-Fit™ secondary microphone input
- Volume control and AUX audio input (1 channel)
- Separate internal/external volume control and AUX audio input w/speaker selectability (2 channel)
- Approved OEM standard option equipment
- 8"L x 3.125"W x 1.75"H

ITEM	PART #
1 Channel PA Amplifier	700962
2 Channel PA Amplifier	700890
1 Channel PA Amplifier w/REI microphone trigger output for remote monitoring of microphone status	710322
18" Power Cable - 3 Pin Pigtail	511919
24" Speaker Cable - 2 Pin Pigtail	511920
18" AUX Control Cable - 6 Pin Pigtail	511921

Ambient Noise Sensor System

- 3" x 5.25" panel
- Automatically adjust volume to compensate for noise levels
- 12 Volt
- 25 Watt power output
- Manage noise levels around rear engine, doors and external speakers

ITEM	PART #
Ambient Noise Sensor System	710290
System Includes:	
Ambient Noise Sensor	710432
Ambient Sensor Microphone	480331
Power Cable	512489

2 Channel Transit PAs

w/Remote Mount Volume Control Panel

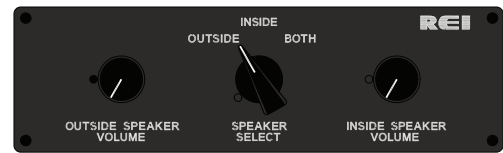

Panel

- 8"L x 2.375"W
- Remote panel mounted internal and external volume control



Front View



Back View

- 8"L x 3.125"W x 1.75"H
- 2 microphone inputs
- AUX audio input

ITEM	PART #
2 Channel Transit PA Amplifier	710146
2 Channel Transit PA Amplifier No AUX Audio to External Speaker	710438
Remote Volume Control Panel	710193
11' Volume Control Cable	512240
13.5" Main Control Cable	512241
18" AUX Control Cable - 6 Pin Pigtail	512242
18" Power Cable - 3 Pin Pigtail	511919

Note: Additional cables required for primary microphone input.

Specialty Harness

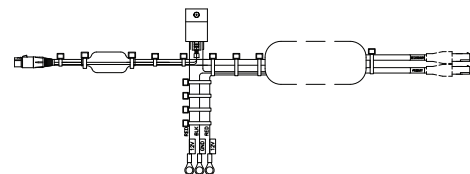

ITEM	PART #
Priority Microphone for Transit Amplifier	710253

ECHO PAs

& Voice Record Dash Model



- 4.16"L x 8"W x 1.88"H panel
- 12/24 Volt
- 50 Watt power output
- Single microphone input w/priority control (Mini-Fit™ connector)
- Internal microphone w/auxiliary microphone input
- Internal and external speaker volume controls
- Approved OEM standard option
- Eliminates unwanted background sounds through active noise cancellation circuit

* Microphone not included

DESCRIPTION	PART #
ECHO PA & Voice Record Dash Module	700854
ECHO PA Module w/o Radio Option	700926

Panel Mounted PA



- 2" x 7" panel
- 12 Volt
- 40 Watt power output
- Single channel
- 2 microphone inputs w/priority control

* Microphone not included

ITEM	PART #
Panel Mount PA	700318

Panel Mounted PA System



- 12 Volt
- 25 Watt power output
- Single channel
- Volume control
- Interior/exterior speaker selection (not included on 2" x 7" panel)

ITEM	PART #
Panel Mount PA System - 2" x 7"	700829
Panel Mount PA System - 2.875" x 10.5"	760501
Panel Mount PA System - 4" x 9"	760850
Panel Mount PA System - 3.75" x 12"	760211

Each PA System Includes:

Hand-Held Microphone with 4 Pin Straight CB Style Connector	480024
---	--------

dynamic microphones / cables

Microphones/Cables

Entertainment Style



ITEM	PART #
Entertainment Microphone w/10' Coiled Cable (#480326 & #511229)	480228
Entertainment Microphone for Van Hool w/10' Coiled Cable - 4 Pin Straight Male XLR (#480326 & #511025)	480332
Entertainment Microphone w/10' Straight Cable - 4 Pin 90° Female XLR	480240
Entertainment Microphone w/o Cable	480326
10' Coiled Cable for Van Hool 4 Pin Straight Male XLR to 4 Pin Straight Female XLR (cross-over wiring)	511025
10' Coiled Cable - 4 Pin Straight Female XLR to 4 Pin 90° Female XLR	511229
10' Straight Cable - 4 Pin Straight Female XLR to 4 Pin 90° Female	512506

Handheld



ITEM	PART #
Handheld Microphone w/3' Coiled Cable - 4 Pin 90° Female XLR	480015
Handheld Microphone w/5' Coiled Cable - 4 Pin 90° Female XLR	480017
Handheld Microphone w/3' Coiled Cable - 4 Pin Straight Female XLR	480080
Handheld Microphone w/3' Coiled Cable - 4 Pin Straight Male XLR (ABC Bus)	480083
Handheld Microphone w/5' Coiled Cable - 4 Pin Straight Female XLR	480325
Handheld Microphone w/3' Coiled Cable - 90° Female XLR and Microphone Clip (480202)	480306
Microphone Mounting Clip	480202

Panel Mount Jacks/Thru-Hole

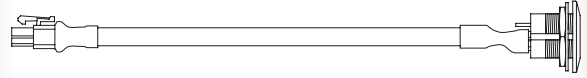

ITEM	PART #
1' Cable - Dynamic 4 Pin XLR Microphone Jack to Radio (4 Pin Female Mini-Fit™)	512130
3' Cable - Dynamic 4 Pin XLR Microphone Jack to Radio (4 Pin Female Mini-Fit™)	512159
6' Cable - Dynamic 4 Pin XLR Microphone Jack to Radio (4 Pin Female Mini-Fit™)	512160
10' Cable - Dynamic 4 Pin XLR Microphone Jack to Radio (4 Pin Female Mini-Fit™)	512161
17' Cable - Dynamic 4 Pin XLR Microphone Jack to Radio (4 Pin Female Mini-Fit™)	512327

Panel Mount Jacks/Surface

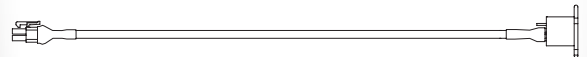

511178, 511412, 512655



512679, 512680

ITEM	PART #
6" Cable - Dynamic 90° 4 Pin XLR Microphone Jack to Radio (4 Pin Female Mini-Fit™)	512720
18" Cable - Dynamic 4 Pin XLR Microphone Jack to Radio (4 Pin Female Mini-Fit™)	511178
79" Cable - Dynamic 4 Pin XLR Microphone Jack to Radio (4 Pin Female Mini-Fit™)	511412
96" Cable - Dynamic 4 Pin XLR Microphone Jack to Radio (4 Pin Female Mini-Fit™)	512655
18" Dynamic Cable - 90° 4 Pin XLR Microphone Jack to Radio (4 Pin Female Mini-Fit™)	512679
79" Dynamic Cable - 90° 4 Pin XLR Microphone Jack to Radio (4 Pin Female Mini-Fit™)	512680

XLR Extension Cables



511775

ITEM	PART #
10' Dynamic Coiled Cable - 4 Pin Male Straight XLR to 4 Pin Female Straight XLR	511775



510309, 510314, 510319, 510324

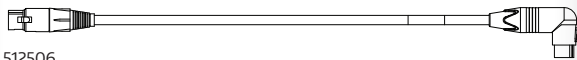

512506

ITEM	PART #
5' Dynamic Straight Cable - 4 Pin Male Straight XLR to 4 Pin Female Straight XLR	510309
10' Dynamic Straight Cable - 4 Pin Male Straight XLR to 4 Pin Female Straight XLR	510314
15' Dynamic Straight Cable - 4 Pin Male Straight XLR to 4 Pin Female Straight XLR	510319
20' Dynamic Straight Cable - 4 Pin Male Straight XLR to 4 Pin Female Straight XLR	510324
10' Straight Cable - 4 Pin Straight Female XLR to 4 Pin 90° Female	512506

Extension Cables w/Trigger Wires

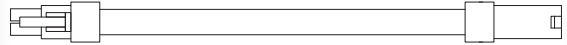

ITEM	PART #
5' Dynamic Cable - 4 Pin Male Mini-Fit™ to 4 Pin Female Mini-Fit™ w/Integrated 5' Trigger Wire	512684

Note: For use with in-dash switch or foot switch

Mini-Fit™ Extension Cables

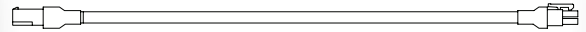

512127, 512128, 512628, 512129, 512140

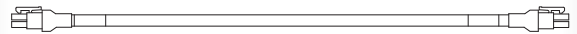

512654

ITEM	PART #
5' Dynamic Cable - 4 Pin Male Mini-Fit™ to Radio (4 Pin Female Mini-Fit™)	512127
10' Dynamic Cable - 4 Pin Male Mini-Fit™ to Radio (4 Pin Female Mini-Fit™)	512128
13' Dynamic Cable - 4 Pin Male Mini-Fit™ to Radio (4 Pin Female Mini-Fit™)	512628
20' Dynamic Cable - 4 Pin Male Mini-Fit™ to Radio (4 Pin Female Mini-Fit™)	512129
45' Dynamic Cable - 4 Pin Male Mini-Fit™ to Radio (4 Pin Female Mini-Fit™)	512140
25' Dynamic Cable - 4 Pin Female Mini-Fit™ to Radio (4 Pin Female Mini-Fit™)	512654

Dynamic Microphone Connectors



Pin Out View

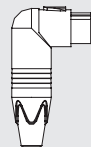

4 Pin 90°
Female XLR



4 Pin Straight
Female XLR



4 Pin Straight
Male XLR

dynamic microphones / cables

"Y" Cables

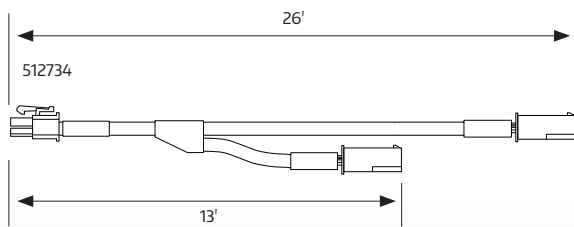
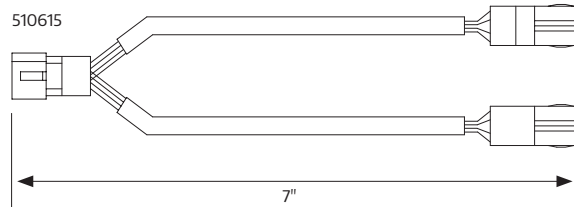
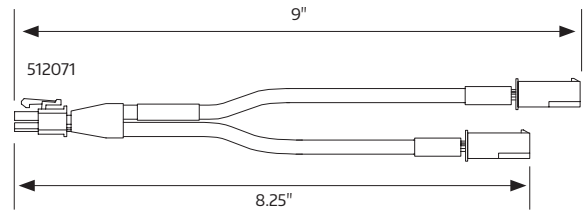
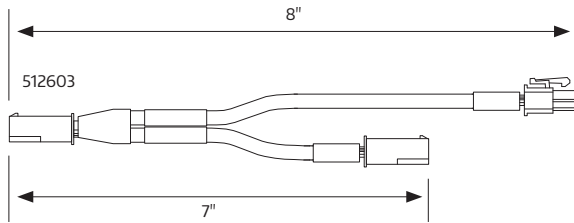

ITEM	PART #
4 Pin Male Mini-Fit™ w/8" to Female Mini-Fit™ and 7" to Male Mini-Fit™	512603
4 Pin Male Mini-Fit™ w/9" to Female Mini-Fit™ and 8.25" to Female Mini-Fit™	512071
4 Pin Male Molex w/(2) 7" to Female Molex	510615
4 Pin Male Mini-Fit™ w/26' to Female Mini-Fit™ and 13' to Female Mini-Fit™	512734

Microphone Jack Panel Assemblies

541038



ITEM	PART #
1 Dynamic Microphone Input Assembly	541038

Includes:

- Dynamic 4 Pin XLR Microphone Jack Mounted in 8" x 1.88" Metal Panel
- 5' Cable to 4 Pin Female Mini-Fit™

541039



ITEM	PART #
2 Dynamic Microphone Inputs and Volume Control Assembly	541039

Includes:

- 9" Cable with XLR Dynamic Microphone Jack and In-Line Volume Control to (2) 4 Pin Male Mini-Fit™ for 2nd Dynamic Mic Input and Audio Input to Radio or PA (512719)

Note: Volume control adjust both microphone inputs – compatible w/all REI radios and PAs w/dynamic input

REI Microphone Adapter Cable

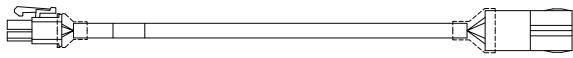

- Converts Molex to Mini-Fit™

ITEM

9" Dynamic Microphone Cable – 4 Pin Female Molex to 4 Pin Female Mini-Fit™

PART

511532

Bosch/Blaupunkt Microphone Adapter Cables

512721



- Converts Blaupunkt/Bosch Mic Cables to 4 Pin Molex for REI Microphone compatibility

ITEM

6" Adapter - 4 Pin Male Molex to 4 Pin Male Din Plug

PART

512721

512722



- Converts Blaupunkt/Bosch Wallmount Jack to 4 Pin Dynamic Mic Jack for REI Microphone compatibility

6" Adapter - 4 Pin Din Plug to Dynamic 4 Pin XLR Thru-Hole Microphone Jack

512722

512598



- Plugs into Blaupunkt Dash/Wallmount Jack and Converts to 4 Pin Straight Male XLR

8" Adapter Cable – 4 Pin Straight Male XLR to 4 Pin Male Din Plug

512598

ACTIA Microphone Adapter Cables

512512

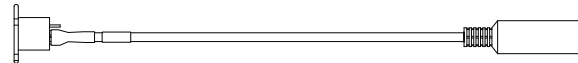

- Replaces ACTIA Microphone Jack with REI Microphone Jack. Adapter Plugs into ACTIA Din Connector Behind Dash.

ITEM

8" Adapter – Dynamic 4 Pin Male XLR Surface Mount Microphone Jack to 5 Pin Male Din Plug

PART

512512

512513



- Plugs into ACTIA Dash/Wallmount Jack and Converts to 4 Pin Molex.

8" Adapter Cable – 4 Pin Male Molex to 5 Pin Female Microphone Socket

512513

512552

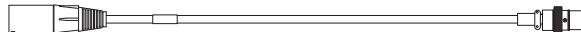

- Plugs into ACTIA Dash/Wallmount Jack and Converts to 4 Pin Straight Male XLR.

5" Adapter Cable – 4 Pin Straight Male XLR to 5 Pin Female Microphone Socket

512552

512570



- Replacement of ACTIA VOX Wireless Microphone System with an REI Wireless Microphone in MCI Vehicles.

8" Mic Adapter – 4 Pin Male Molex to 5 Pin Male Din Plug

512570

dynamic microphones /cables

Dynamic Headphone Microphone System

Toggle Switch Control Option

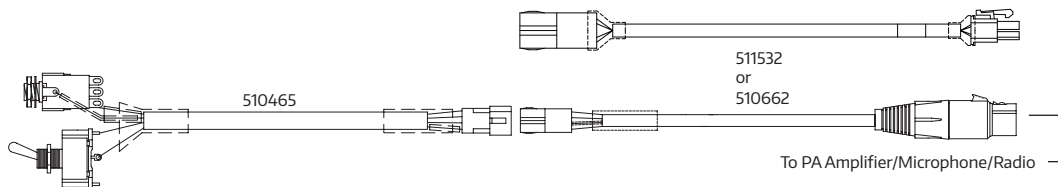

Foot Switch Control Option

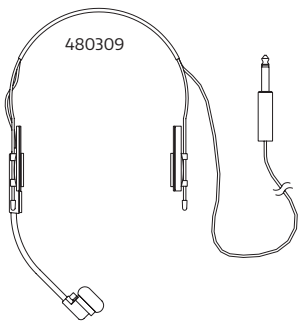
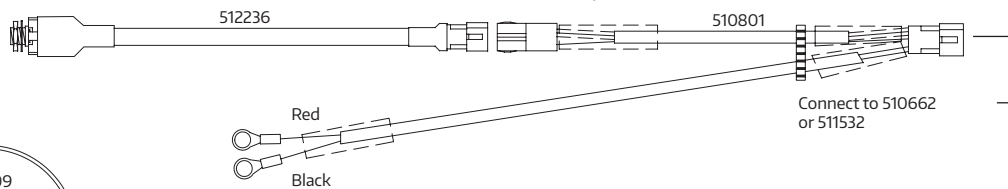

Belt Clip Pre-amp Option

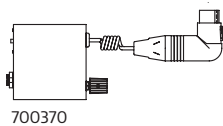

Belt Clip Pre-amp Option

ITEM	PART #
Dynamic Headset Microphone	480309
Microphone Jack - Belt Clip Pre-amp w/Volume Control	700370

Toggle Switch Control Option

ITEM	PART #
Dynamic Headset Microphone	480309
Headphone Microphone Jack w/Switch	510465
7" Dynamic Microphone Cable Extension Optional	510662
9" Dynamic Microphone Cable - Molex to Mini-Fit™ Adapter	511532

Footswitch Control Option

ITEM	PART #
Dynamic Headset Microphone	480309
Headphone Microphone Jack w/o Switch	512236
7" Dynamic Microphone Cable Extension	510662
15' Footswitch Microphone Cable Harness	510801
9" Dynamic Microphone Cable - Molex to Mini-Fit™ Adapter	511532

carbon microphones / cables

Carbon Handheld Microphones



ITEM	PART #
Handheld Microphone w/3' Coiled Cable - 4 Pin Straight CB Style Connector	480024
Handheld Microphone w/3' Coiled Cable - 5 Pin Straight CB Style Connector	480271
Microphone Mounting Clip	480201

Carbon Microphone Connector

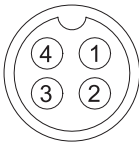

Pin Out View

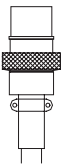

4 Pin CB Style

Carbon Microphone Jack Cables



512341, 512365

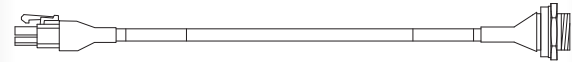

512200, 512218

ITEM	PART #
1' Cable - Carbon 4 Pin CB Style Microphone Jack to Radio (3 Pin Female Mini-Fit™)	512341
3' Cable - Carbon 4 Pin CB Style Microphone Jack to Radio (3 Pin Female Mini-Fit™)	512365
3' Cable - Carbon 4 Pin CB Style Microphone Jack to Radio (4 Pin Female Mini-Fit™)	512200
13' Cable - Carbon 4 Pin CB Style Microphone Jack to Radio (4 Pin Female Mini-Fit™)	512218

Carbon Microphone Extension Cables

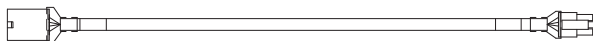

512518

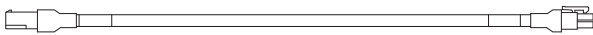

512129

ITEM	PART #
20' Carbon Cable - 3 Pin Male Mini-Fit™ to Radio (3 Pin Female Mini-Fit™)	512518
20' Carbon Cable - 4 Pin Male Mini-Fit™ to Radio (4 Pin Female Mini-Fit™)	512129

gooseneck microphones

Vandal Resistant Gooseneck Microphones

- REI gooseneck microphones utilize 1.75" mount bases.
- No on/off switch. Must be triggered using external dash or foot switch.

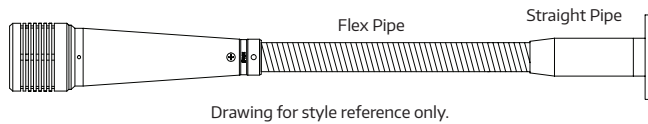

4 Pin Straight Female XLR

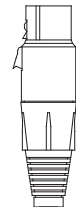

Molex Connector

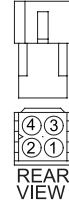

Mini-Fit™ Connector

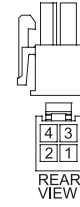

Bare Wires



ITEM	PART #	4 Pin Straight Female XLR	Molex Connector	Mini-Fit™ Connector	Bare Wires
25" VR Microphone w/24" Cable	480304	X			
30" VR Microphone w/24" Cable	480265	X			
30" VR Microphone w/24" Cable	480113BK	X			
33" VR Microphone w/24" Cable	480235	X			
33" VR Microphone w/120" Cable	480303	X			
35" VR Microphone w/24" Cable	480301	X			
36" VR Microphone w/90" Cable	480248	X			
30" VR Microphone w/60" Cable	480206BK		X		
36" VR Microphone w/48" Cable	480239		X		
43" VR Microphone w/18" Straight Pipe, 19" Flex, 31" Cable	480031BK		X		
48" VR Microphone w/4" Straight Pipe, 38" Flex, 26" Cable	480279		X		
30" VR Microphone w/4" Straight Pipe, 20" Flex, 24" Cable	480305			X	
33" VR Microphone w/24" Cable	480323			X	
25" VR Microphone w/35" Cable	480316				X
30" VR Microphone w/35" Cable	480317				X
33" VR Microphone w/35" Cable	480318				X
36" VR Microphone w/35" Cable	480319				X

Foot Switches & Cables



290042



290119

ITEM	PART #
Foot Switch for Use w/Gooseneck Microphone 1" Plunger Style	290042
Foot Switch for Use w/Gooseneck Microphone Pedal Style	290078
Plunger Style Foot Switch in Metal Housing	290119
Cable, 15' for Use w/Foot Switch (Consists of 290042 Foot Switch and 511179 Cable)	510801
Cable, 7.5' for Use w/Foot Switch	511724
Cable, 15' for Use w/Foot Switch	511179

Additional foot switch cables available in various lengths

Gooseneck Microphones

- REI gooseneck microphones utilize 1.75" mount bases.
- Includes on/off switch.

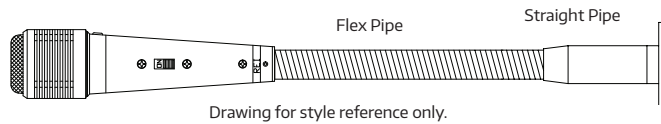

4 Pin Straight Female XLR

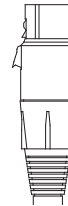

Molex Connector

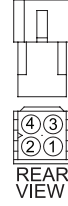

Mini-Fit™ Connector



Bare Wires



ITEM	PART #	4 Pin Straight Female XLR	Molex Connector	Mini-Fit™ Connector	Bare Wires
25" Microphone On/Off Switch w/50" Cable	480117BK	X			
30" Microphone On/Off Switch w/70" Cable	480245	X			
30" Microphone On/Off Switch w/125" Cable	480286	X			
30" Microphone On/Off Switch w/24" Cable	480324	X			
33" Microphone On/Off Switch w/43" Cable	480246	X			
36" Microphone On/Off Switch w/40" Cable	480054BK	X			
25" Microphone On/Off Switch w/51" Cable	480047BK		X		
30" Microphone On/Off Switch w/46" Cable	480062BK		X		
33" Microphone On/Off Switch w/43" Cable	480076BK		X		
36" Microphone On/Off Switch w/40" Cable	480027BK		X		
43" Microphone On/Off Switch w/18" Straight Pipe, 19" Flex, 33" Cable	480039BK		X		
44" Microphone On/Off Switch w/32" Cable	480259		X		
48" Microphone On/Off Switch w/18" Straight Pipe, 24" Flex, 28" Cable	480074BK		X		
25" Microphone On/Off Switch w/24" Cable	480310			X	
30" Microphone On/Off Switch w/3" Straight Pipe, 19" Flex, 24" Cable	480299			X	
30" Microphone On/Off Switch w/24" Flex, 48" Cable	480289				X
36" Microphone On/Off Switch w/30" Flex, 48" Cable	480250NC*				X

*Note: Wires are pinned and a separate 4 Pin Male Molex plug is included.

Slimline Mini Gooseneck



ITEM	PART #
Slimline 19" Gooseneck Microphone Package	750248
Kit Includes:	
Slimline 19" Gooseneck Microphone w/15' PA Input Cable (Mini-Fit™) and 10' Foot Switch Cable	480329
Plunger Style Foot Switch in Metal Housing	290119

wireless microphones

Handheld Microphone

Microphone

- 16 user selectable channels
- Powered by 3 rechargeable NiMH batteries
- 7 hour normal battery life

Charging Station

- 12/24 Volt
- LED indication of charge status
- Refresh cycle to ensure optimum charge

Receiver

- Dual PLL tuner automatically selects strongest signal
- Radio signal indicator
- Audio signal indicator
- Audio level indicator
- 12/24 Volt
- Power on/off switch
- 16 user selectable channels



MICROPHONE & CHARGING STATION



RECEIVER

ITEM	PART #
System 2000 Microphone Kit	750075
REI Retrofit Wireless Kit	750253
Wall Mount Kit for Wireless Receiver & Charger	561049

ITEM	PART #	EC-750 System	REI Radio or Transit PA	Elite System	System 2000	Gemini/Blaupunkt Retrofit System	ACTIA
Wireless microphone	700598	✓	✓	✓	✓	✓	✓
Wireless receiver	700862	✓	✓	✓	✓	✓	✓
Charging station	700532	✓	✓	✓	✓	✓	✓
Receiver to Molex Mic Input 20'	511659		✓		✓		
Molex to Mini-Fit™ cable	511532		✓				
Receiver power cable	511820		✓		✓		
Receiver to SPU audio cable	511903			✓			
Receiver to SPU power cable	511905			✓			
Charger power cable	511822		✓	✓	✓		
Receiver to Blaupunkt cable	511847					✓	
Mic adapter cable	512407					✓	
Receiver to Radio or Driver Control Module Mini-Fit™ 20'	512611	✓					
Cable In-line Wireless Relay Isolator	512633						✓
Rechargeable AA Battery, NiMH 1300 MAH	470010	✓	✓	✓	✓	✓	✓

Note: 6 piece minimum purchase required.

Lapel Microphone

Microphone

- Unidirectional microphone w/metal spring clip
- 4' cable w/4 Pin mini XLR connector



Belt Pack Transmitter

- 16 user selectable channels
- 4 Pin mini XLR receptacle
- On/off switch
- Low battery LED
- Requires 3 AA batteries (not included)

Receiver

- Dual PLL tuner automatically selects strongest signal
- Radio signal indicator
- Audio level indicator
- 12/24 Volt
- Power on/off switch
- 16 user selectable channels

ITEM	PART #	EC-750 System	REI Radio or Transit PA	Elite System	System 2000
Lapel microphone	480320	✓	✓	✓	✓
Belt pack transmitter	710166	✓	✓	✓	✓
Wireless receiver	700862	✓	✓	✓	✓
Receiver to Molex Mic Input 20'	511659		✓		✓
Molex to Mini-Fit™ cable	511532		✓		
Receiver power cable	511820		✓		✓
Receiver to SPU audio cable	511903			✓	
Receiver to SPU power cable	511905			✓	
Receiver to Radio or Driver Control Module Mini-Fit™ 20'	512611	✓			



Headset Microphone

Microphone

- Unidirectional microphone
- 4' cable w/4 Pin mini XLR connector
- Adjustable headband

Belt Pack Transmitter

- 16 user selectable channels
- 4 Pin mini XLR receptacle
- On/off switch
- Low battery LED
- Requires 3 AA batteries (not included)

Receiver

- Dual PLL tuner automatically selects strongest signal
- Radio signal indicator
- Audio level indicator

ITEM	PART #	EC-750 System	REI Radio or Transit PA	Elite System	System 2000
Headset microphone	480321	✓	✓	✓	✓
Belt pack transmitter	710166	✓	✓	✓	✓
Wireless receiver	700862	✓	✓	✓	✓
Receiver to Molex Mic Input 20'	511659		✓		✓
Molex to Mini-Fit™ cable	511532		✓		
Receiver power cable	511820		✓		✓
Receiver to SPU audio cable	511903			✓	
Receiver to SPU power cable	511905			✓	
Receiver to Radio or Driver Control Module Mini-Fit™ 20'	512611	✓			

Other configurations available. Contact your REI representative for assistance.

EC-750 driver control module/radio

EC-750 Driver Control Module Features

- Source control including audio/video
- Expandable audio/video sources
- 2 PA inputs w/independent level adjustments
- Centralized control of all system settings
- LCD graphics display shows status of all system parameters
- Separate driver's section with radio or AUX inputs
- User settings stored during power loss
- Independent tone controls for all sources
- Integrated control and display of DVD functions



ECD-5500 Radio Features



- CD stereo receiver
- 18 FM, 12 AM, 7 WB radio station presets
- USA/EURO radio bands
- Plays MP3/WMA formats
- Displays ID3 tag information
- Bluetooth® audio streaming
- USB type-A with iPod®/iPhone® charging and playback control
- 2 AUX inputs (front 3.5mm stereo jack/Rear RCA)
- User settings stored during power loss
- 30 day clock back-up
- Integrated Bluetooth® microphone with optional external microphone input for hands free cellular calling
- Anti-skip CD mechanism

ITEM	PART #
EC-750 Driver Control Module	710467
ECD-5500 Radio	710473
ECD-5500 Radio (ISO connector) to EC-750 Driver Control Module (10 Pin Female Mini-Fit™, 4 Pin Male Mini-Fit™, and 2 Pin Male Mini-Fit™)	512604
10" USB Weather Resistant Panel Mount w/Cover to Male USB Connector	512485

EC-750 Driver Control Module Features

- Source control including audio/video
- Expandable audio/video sources
- 2 PA inputs w/independent level adjustments
- Centralized control of all system settings
- LCD graphics display shows status of all system parameters
- Separate driver's section with radio or AUX inputs
- User settings stored during power loss
- Independent tone controls for all sources
- Integrated control and display of DVD functions

EVR-6500D Multi-Media Radio Features



- Preset up to 30 radio stations (18 FM, 12 AM)
- 6.2" touch screen
- Displays ID3 tag information
- Bluetooth® audio streaming and hands-free calling
- USB (type A & mini-B)/MicroSD input
- Rear view camera input
- iPod® playback control
- CD/DVD player



ITEM	PART #
EC-750 Driver Control Module	710467
EVR-6500D	710464
EVR-6500D Multi-Media Radio (10 Pin Male Mini-Fit™) to EC 750 Driver Control Module (10 Pin Female Mini-Fit™ and 4 Pin Male Mini-Fit™)	512691

Note: Aux input can be used with MP1000

EVR-6500D Accessories

Camera Observation System

ITEM	PART #
Camera w/Motorized Lens Cover, 2.9mm	710343
18' Adapter Cable – 5 Pin Din to RCA Video and Power Wires	512666
65' Camera Cable	512369
33' Camera Cable	512401
15' Camera Cable	512400

Dashmount USB Audio Input

ITEM	PART #
10" USB Weather Resistant Panel Mount w/Cover to Male USB Connector	512485

GPS Mapping

ITEM	PART #
GPS Antenna	710469
GPS Mapping	Contact REI

video/multi-media sources

DVD Stereo Radios with PA



For detailed information, go to page 11.

DESCRIPTION	PART #
VR-3000 w/Bare Wires	710248
VR-3000 w/Tri-Amp Plugs	710386
VR-3000 w/Thor Plug	710302
VR-3000 w/Thomas/Arboc Plug	710326



For detailed information, go to page 10.

ITEM	PART #
VR-6000D w/Bare Wires	710497

VR-6000D w/PA

ITEM	PART #
VR-6000D w/PA (Includes 2 Dynamic Mic Inputs)	710524

VR-6000D w/PA and Thor Plug	710541
-----------------------------	--------

System Includes:

Dynamic Microphone	480015
36" Microphone Cable	512159

DVD Players



- 12/24 Volt
- NTSC/PAL compatible
- Blue LCD display
- Amber LED backlighting
- Special circuitry increases pre-amp level outputs to 2.8 Volts, the highest in the industry

DESCRIPTION	PART #
DVD Player for EC-750 and Elite Systems	710089
DVD Player for System 2000 or Non REI AV System	710087
DVD Player for Advanced System	710088

Video Source Mount Kits



Electronic components not included

DESCRIPTION	PART #
Equipment Mount Kit	561047

Compatible with:

- REI DVD Players – 710087 / 710088 / 710089
- REI HDMI Switch – 710452 / 710522
- MP-1000 – 710273

Multi-Media Panels

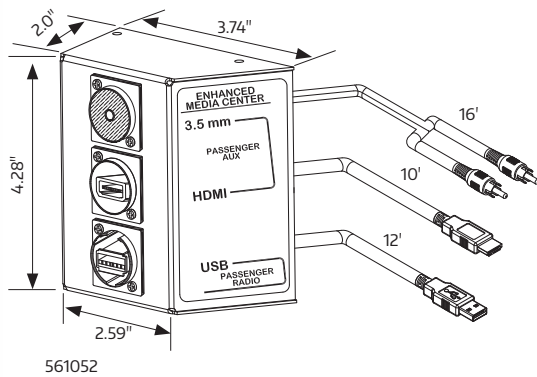

512537, 512727

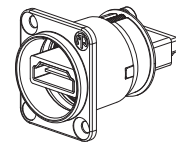

512537 HDMI Connector



512485, 512629

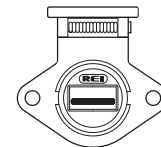

512485 - USB Female Connector

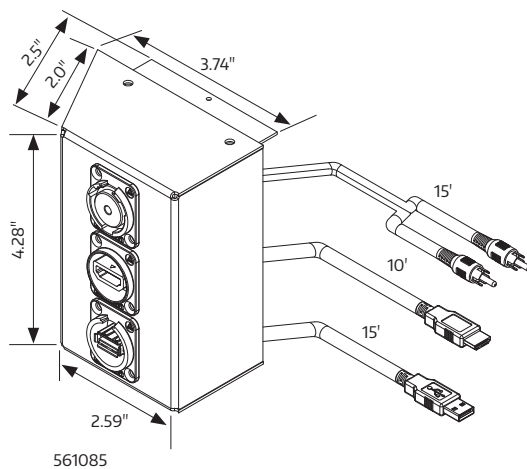

561085

DESCRIPTION	PART #
Multi-Media Hub w/3 Inputs - 1 - 3.5mm Aux Audio / 1 - HDMI / 1 - USB	561052
Multi-Media Hub w/3 Inputs - 1 - 3.5mm Aud Audio / 1 - HDMI / 1 - USB	561085
15' Cable - HDMI Locking Connector to HDMI Panel Mount Recepticle	512727
20' Cable - HDMI Locking Connector to HDMI Panel Mount Recepticle	512537
10" USB Weather Resistant Panel Mount w/Cover to Male USB Connector	512485
6' USB Weather Resistant Panel Mount w/Cover to Male USB Connector	512629
3' Adapter Cable - 4 Pin Female Mini-Fit™ to Dual Male RCA	511885

Note: Additional power and video cables may be necessary for AV system configuration

Digital Video Player

Let REI's digital video player become your digital tour guide. Play back customized pre-recorded video narratives for your tour groups. Your content can be manually activated by the driver controller or automatically triggered based on GPS coordinates or date/time. Plus, offer your tours in different languages to better serve your clientele.



DESCRIPTION	PART #
Digital Video Player	710262
Driver Controller	710075



DRIVER CONTROLLER

- Uses compact flash cards for digital audio/video storage
- Audio/video files can be auto-played via GPS coordinates or date/time
- Designed to integrate into existing entertainment systems

LCD monitors

REI knows a picture says a thousand words. That is why our HD monitors reveal a more stunning viewing experience for your passengers. Our monitors have brilliant vivid color, dramatic contrast and impeccable image clarity to see details at their best. Choose from wedge, flip-down or wall mounted monitors in a variety of sizes.

Common LCD Monitor Specs

- Widescreen
- LED backlight
- 160° viewing angle
- 12/24 Volt
- BNC composite video input
- HDMI HD video input
- Remote control

Power cables – see page 42

ITEM	PART #
15.4" LCD – Wall Mount	710221
20" LCD – Wall Mount	710301
23" LCD – Wall Mount	710468
27" LCD – Wall Mount	710407

Each monitor requires a mount kit.

ITEM	PART #
15.4" Surface Mount Kit	750226
20" Surface Mount Kit	750251
23" Surface Mount Kit	750291
27" Surface Mount Kit	750256
Flush Mount Kit	750250

Compatible with:

- 20" LCD – Wall Mount (710301)
- 23" LCD – Wall Mount (710468)
- 27" LCD – Wall Mount (710407)



15.4" HD

- 1680 x 1050 resolution

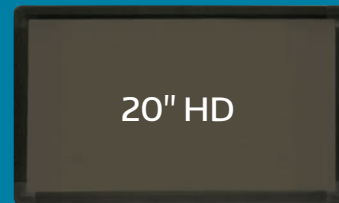

20" HD

- 1600 x 900 resolution

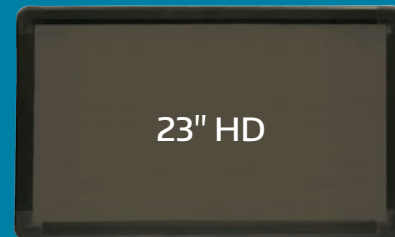

23" HD

- 1920 x 1080 resolution

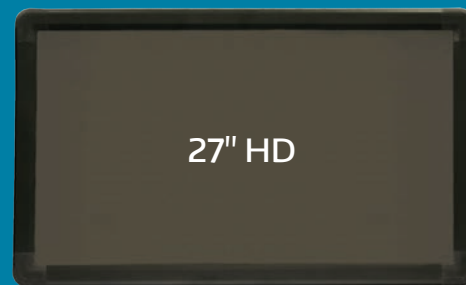

27" HD

- 1920 x 1080 resolution

LCD – Flip-Down Monitors

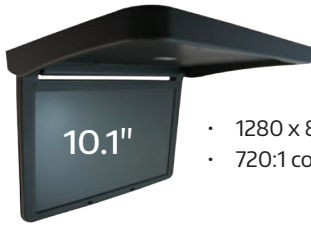

10.1"

- 1280 x 800 resolution
- 720:1 contrast



15.6"

- 1920 x 1080 resolution
- 800:1 contrast



15.4" HD

- 1440 x 900 resolution
- 800:1 contrast
- Motorized mechanism
- HDMI HD video input



19" HD

- 1440 x 900 resolution
- 1000:1 contrast
- Motorized mechanism
- HDMI HD video input
- HDMI E Input

Common Flip-Down Monitor Specs

- Widescreen
- LED backlight
- 160° viewing angle
- 12/24 Volt
- BNC composite video input
- Remote control

Power cables – see page 42

ITEM	PART #
10.1" LCD – Industrial Flip Down/Manual	710462
15.6" LCD – Industrial Flip Down/Manual	710557
15.4" LCD – Motorized	710211
19" LCD – Motorized	710213

so much to see

LCD monitors

LCD – Wedge Monitors

Common Monitor Specs

- Widescreen
- LED backlight
- 12/24 Volt
- BNC composite video input
- HDMI HD video input
- HDMI E input
- Remote control

Power cables – see at right



10.1" HD

- 1280 x 800 resolution
- 900:1 contrast
- 160° viewing angle



15.6" HD

- 1920 x 1080 resolution
- 188° viewing angle

ITEM	PART #
10.1" LCD – Wedge	710375
10.1" Mount Bracket	560968
15.6" LCD - Wedge	710530
15.6" Mount Bracket	560941

10.1" LCD Retro Fit Kit



Upgrade your REI CRT monitors with new LCDs

ITEM	PART #
10.1" LCD Retro Fit Kit	769975
Kit Includes:	
10.1" LCD Monitor	710375
Adapter	760881
Mount Bracket	560968

Power Cables & Harnesses

ITEM	PART #
1' Power - 4 Pin Female – Mini-Fit™ to Bare Wires	512549
3' Power - 4 Pin Female – Mini-Fit™ to Bare Wires	512550
6' Power - 4 Pin Female – Mini-Fit™ to Bare Wires	511563
15' Power - 4 Pin Female – Mini-Fit™ to Bare Wires	511858
30' Power - 4 Pin Female – Mini-Fit™ to Bare Wires	511859
50' Power - Mini-Fit™ to Bare Wires	511860
25' Power - Mini-Fit™ to #10 Ring Terminals	512501
3' Power – 4 Pin Female Mini-Fit™ to 4 Pin Female Mini-Fit™	511867
7' Power – 4 Pin Female Mini-Fit™ to 4 Pin Female Mini-Fit™	512630
Power Harness – 3 Female Mini-Fit™ Taps 5'/7'/33' to #10 Ring Terminals	512502
Power Harness – 3 Female Mini-Fit™ Taps 6'/21'/33' to #10 Ring Terminals	511931
Power Harness – 4 Female Mini-Fit™ Taps 5'/7'/18'/27' to #10 Ring Terminals	511930
12/24V Power "Y" Cable 4 Pin Female Mini-Fit™ 2/6" to Male Mini-Fit™ and 12" to Female Mini-Fit™	512667

LCD trim kits

ABC T Series Coaches

ITEM	PART #
15.4" LCD Wallmount (#710221) Front Bulk Head Monitor Kit	750139

Kit Includes:

15.4" LCD Wallmount	710221
Mount Bracket	750139
6' Monitor Power - Mini-Fit™ to Bare Wires	511563

Prevost H & XL Coach

ITEM	PART #
15.6" LCD Wedge Monitor Parcel Rack Trim Kit - Left/Right	750214

MCI J Coach – 2014 Parcel Rack

Implemented J Coach Unit #66699
October 2013

ITEM	PART #
10.1" LCD Mount Kit – Left	750304
10.1" LCD Mount Kit – Right	750305
10.1" LCD Trim – Left	551050
10.1" LCD Trim– Right	551051
15.6" LCD Mount Kit – Left	750273
15.6" LCD Mount Kit – Right	750274
15.6" LCD Trim – Left	550989
15.6" LCD Trim– Right	550990

MCI E/J Coach – Prior to 2014

ITEM	PART #
10.1"/15.4" LCD Mount Kit – Left	750149
10.1"/15.4" LCD Mount Kit – Right	750148
10.1" LCD Trim – Left	550781
10.1" LCD Trim– Right	550780
15.6" LCD Trim – Left	550796
15.6" LCD Trim– Right	550795

Setra Coach

ITEM	PART #
15.4" LCD Motorized Monitor w/ Replacement Roof Mount Trim Kit	769911

Kit Includes:

15.4" LCD Monitor - Motorized	710211
Metal Mounting Plate - 15.4" LCD Monitor - Motorized	540880
6' Monitor Power - Mini-Fit™ to Bare Wires	511563
5' Gray "U" Channel Rubber Trim	080106
Screw 8/32 x 1" (6 pieces)	020177

MCI D Coach – 2014 Parcel Rack

Implemented D Coach Unit #13357
March 2014

ITEM	PART #
10.1" LCD Mount Kit – Left	750286
10.1" LCD Mount Kit – Right	750285
10.1" LCD Trim – Left	551037
10.1" LCD Trim– Right	551036

MCI D Coach – Prior to 2014

ITEM	PART #
10.1"/15.6" LCD Mount Kit – Left	750144
10.1"/15.6" LCD Mount Kit – Right	750143
10.1" LCD Trim – Left	550779
10.1" LCD Trim– Right	550778
15.6" LCD Trim – Left	550794
15.6" LCD Trim– Right	550793

TEMSA TS45 Coach

ITEM	PART #
15.6" LCD Mount Kit with Trim – Left	750318
15.6" LCD Mount Kit with Trim – Right	750319
15.6" LCD Mount Kit with Trim – Left	750326
15.6" LCD Mount Kit with Trim – Right	750325

HDMI E modules/cables

HDMI E Distribution Amplifier



- 1 HD digital input
- 4 HD digital output
- HDMI ver. 1.3 certified
- HDCP compliant
- 2 power in/out connectors
- Input voltage range 8-32 volts
- Automotive grade locking Type E HDMI connectors

ITEM

HDMI E Distribution Amplifier – Single Input to 4 HDMI E Output

PART

710523

6 Channel Video Source Selector with HD Output



- 3 composite analog inputs with 1080p upscaling
- 3 HD digital inputs
- 1 HD digital output
- HDMI ver. 1.3 certified
- HDCP compliant
- 1 digital audio output
- 1 analog audio output
- Manual/auto source detect
- Serial communication
- Input voltage range 8-32 volts
- Automotive grade locking Type E HDMI connectors

ITEM

6 Channel Video Selector – 3 Selectable HDMI E/3 BNC Inputs to Single HDMI E Output

PART

710522

HDMI E Cables

REI's Automotive Grade Type E HDMI connector offers an enhanced experience for next generation Infotainment systems and HD media entertainment solutions. Approved by the HDMI Association, our connector provides customers with HD image quality and reliable data transmission, making it ideal for mobile and commercial applications. Standard HDMI connectors are non-locking and are not durable enough for mobile and commercial applications. HDMI E is a highly durable, positive locking connector that is simple to use and ensures a reliable connection in the harshest conditions. It has become a critical component in the design of top-grade next generation vehicle infotainment systems.

- Automotive environment grade
- Positive locking performance
- Strong performance against insertion and extraction force
- SMT type contact to minimize size and maximize connection reliability
- HDMI ver. 1.3 certified
- RoHS compliant



ITEM	PART #
1' HDMI Cable - Male HDMI E to Male HDMI E	512697
3' HDMI Cable - Male HDMI E to Male HDMI E	512698
7' HDMI Cable - Male HDMI E to Male HDMI E	512699
10' HDMI Cable - Male HDMI E to Male HDMI E	512700
15' HDMI Cable - Male HDMI E to Male HDMI E	512701
20' HDMI Cable - Male HDMI E to Male HDMI E	512702
25' HDMI Cable - Male HDMI E to Male HDMI E	512703
30' HDMI Cable - Male HDMI E to Male HDMI E	512704
35' HDMI Cable - Male HDMI E to Male HDMI E	512705

HDMI E Adapter Cable

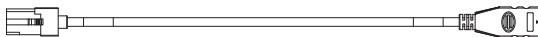

ITEM	PART #
Cable Adapter - HDMI E Male to HDMI A Female	512707

- HDMI ver. 1.3 certified

HDMI cables/connectors

HDMI Cables with Security Screw



ITEM	PART #
1' HDMI Cable w/Security Screw - Male to Male	512546
3' HDMI Cable w/Security Screw - Male to Male	512527
6' HDMI Cable w/Security Screw - Male to Male	512528
7' HDMI Cable w/Security Screw - Male to Male	512677
10' HDMI Cable w/Security Screw - Male to Male	512529
15' HDMI Cable w/Security Screw - Male to Male	512530
20' HDMI Cable w/Security Screw - Male to Male	512531
25' HDMI Cable w/Security Screw - Male to Male	512639
30' HDMI Cable w/Security Screw - Male to Male	512532
35' HDMI Cable w/Security Screw - Male to Male	512678
40' HDMI Cable w/Security Screw - Male to Male	512640
49.2' HDMI Cable w/Security Screw - Male to Male	512547
20' HDMI Cable - Male to 90° Male	512548

HDMI/Power Harnesses

ITEM	PART #
15' HDMI Cable with Integrated 12/24V Power - 4 Pin Female Mini-Fit™ to 4 Pin Female Mini-Fit™	512536

Connectors/Adapters



110993



110991

ITEM	PART #
Adapter 90° HDMI - Male to HDMI Female	110993
HDMI Panel Mount Receptacle	110991

The HDMI Advantage

HDMI technology is the global standard for connecting high-definition equipment. HDMI is the intelligent, all-digital interface that delivers both dazzling quality and unmatched ease of use. More than 1,600 of the world's largest consumer electronics, PC and mobile device manufacturers incorporate HDMI connectivity into their products.



One Cable Does It All

HDMI technology transmits crystal-clear digital video, multi-channel surround audio, and advanced control data through a single cable. One HDMI cable can replace as many as eleven older cables, making your entertainment system easier to connect and easier to upgrade. You won't find that level of elegant simplicity in any other connection.

Pure Digital Performance

Unlike older cables, an HDMI connection transmits uncompressed audio-video data in 100 percent digital form. That adds up to world-class viewing experience, with pixel-for-pixel video accuracy and audiophile-quality sound.

1080p and beyond - HDMI is built to accommodate extremely high-resolution video, with bandwidth to spare for the next generation of HD equipment.

System intelligence - HDMI-connected components have the ability to query each other's capabilities and automatically adjust themselves for optimal viewing. A TV and a DVD player, for example, can auto-negotiate settings like resolution and aspect ratio.

Connect Everything

HDMI technology is the de-facto standard for connecting HD equipment. You'll find HDMI connectors on a growing list of products including digital video players, laptops and netbooks, gaming consoles, camcorders, digital still cameras, and mobile devices, giving you even more options on how you connect to the expanding universe of HD entertainment.

video distribution amplifiers & cables

BNC Video Distribution Amp

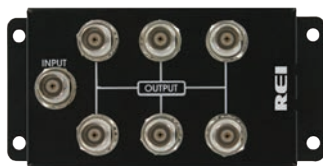

700887

- 12/24 Volt
- BNC connectors
- Requires power cable – see below

ITEM	PART #
Video Distribution Amplifier – BNC	700887

BNC Video Cables

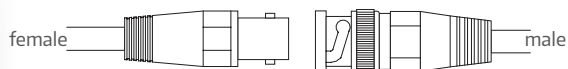

ITEM	PART #
1' BNC Coax Cable - Male to Male	512299
3' BNC Coax Cable - Male to Male	511253
7' BNC Coax Cable - Male to Male	510406
10' BNC Coax Cable - Male to Male	510443
12' BNC Coax Cable - Male to Male	510690
15' BNC Coax Cable - Male to Male	511062
18' BNC Coax Cable - Male to Male	511252
20' BNC Coax Cable - Male to Male	510407
27' BNC Coax Cable - Male to Male	511160
33' BNC Coax Cable - Male to Male	510928
44' BNC Coax Cable - Male to Male	510929

Distribution Amp Replacement Kits

Replacement for Video Distribution Amplifier 700459

ITEM	PART #
Kit Includes:	750095
Video Distribution Amplifier	700887
9" Power Adapter Male Cinch to 4 Pin Female Mini-Fit™ 24V	511607
3' 4 Pin Female Mini-Fit™ to 4 Pin Female Mini-Fit™ 12/24V	511867
9" Power Adapter Female Cinch to 4 Pin Male Mini-Fit™ 24V	511642

Replacement for Video Distribution Amplifier 700769

ITEM	PART #
Required:	
Video Distribution Amplifier	700887
3' 4 Pin Female Mini-Fit™ to 4 Pin Female Mini-Fit™ 12/24V	511867

BNC Connectors/Adapters

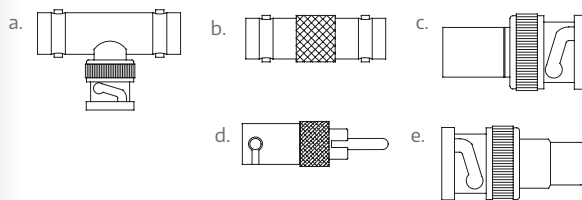

ITEM	PART #
BNC "T" Connector Male to 2 Female (a.)	110195
BNC Female to BNC Female (b.)	110305
BNC 75 OHMS Terminator (c.)	110198
BNC Female to RCA Male (d.)	110416
BNC Male to RCA Female (e.)	110468

BNC Video & Power Cable

ITEM	PART #
3 Monitor Audio/Video Cable Kit	750106
Hardware Pack	060106
1 - 7' BNC Coax Video Cable - RG-6	510406
1 - 12' BNC Coax Video Cable - RG-6	510690
1 - 24' BNC Coax Video Cable - RG-6	510414
Loose Wire Pack	510943
2 - 6' Power Cable - Mini-Fit™	511563
1 - 15' Power Cable - Mini-Fit™	511858
1 - 30' Power Cable - Mini-Fit™	511859
6 Monitor Audio/Video Cable Kit	750107
Hardware Pack	060106
1 - 7' BNC Coax Video Cable - RG-6	510406
2 - 20' BNC Coax Video Cable - RG-6	510407
2 - 33' BNC Coax Video Cable - RG-6	510928
1 - 44' BNC Coax Video Cable - RG-6	510929
Loose Wire Pack	510943
2 - 6' Power Cable - Mini-Fit™	511563
1 - 15' Power Cable - Mini-Fit™	511858
2 - 30' Power Cable - Mini-Fit™	511859
2 - 50' Power Cable - Mini-Fit™	511860

RCA Audio/Video Cables



ITEM	PART #
3' RCA Cable - Dual Male to Male	510564
10' RCA Cable - Dual Male to Male	510572
25' RCA Cable - Dual Male to Male	511653
10' RCA Cable - Single Male to Male	510300
15' RCA Cable - Single Male to Male	510339
25' RCA Cable - Single Male to Male	510779
3' RCA Cable - Single Male to Male	530018
6' RCA Cable - Video and Stereo Audio (3X) Male to Male	512153
10' RCA Cable - Video and Stereo Audio (3X) Male to Male	512086
RCA "Y" Cable - Dual Male to Single Female	510902
RCA "Y" Cable - Single Male to Dual Female	510136
3' RCA Cable - Single Male to Female	511031
6' RCA Cable - Single Male to Female	511398
15' RCA Cable - Single Male to Female	511397

RCA Couplers/Adapters

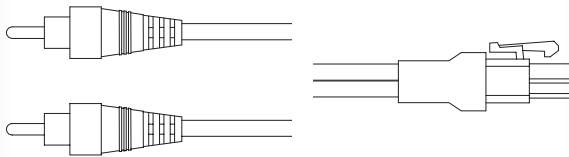

ITEM	PART #
RCA Female to RCA Female Coupler	110627
3.5mm to RCA Mono Adapter	111012
3' Dual Male RCA to 4 Pin Female Mini-Fit™	511494
6' Dual Male RCA to 4 Pin Female Mini-Fit™	512668

Video & Power Combo Cables

ITEM	PART #
7'/20'/35' Combination Power - Mini-Fit™ to Mini-Fit™ 24V	512563
12' Crossover Harness 12/24V	512564

ACTIA Adapter Cables

ITEM	PART #
1' Power- 3 Pin Male AMP to (2) 3 Pin Female AMP	512685

Note: Motorcoach Industries only

passenger safety announcement player

MP-1000 Passenger Safety Announcement Player

REI's MP-1000 is an industry innovation in passenger safety announcements. Our affordable digital media player allows you to customize your video and audio safety message and obtain a date and time log to verify your announcement has been played. The REI MP-1000 is equipped with auxiliary video and audio inputs to interface with your existing entertainment system and automatically switches between the two. Playback options include: AutoPlay upon power-up; loop continuous message; or stop/start priority message utilizing a convenient remote play button.

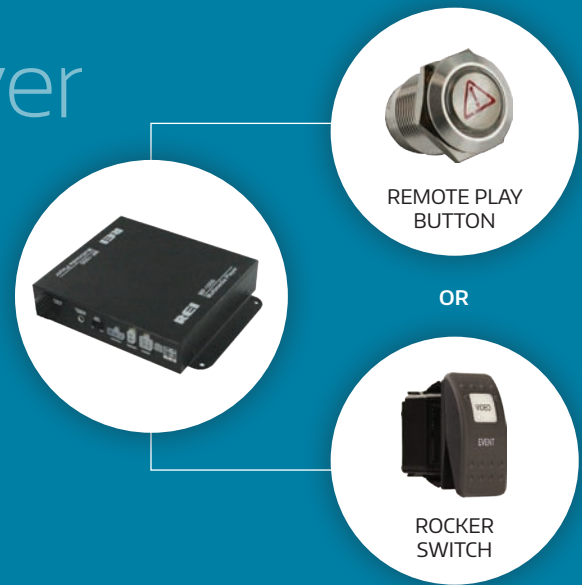

PART #	DESCRIPTION	EC-750	System 2000 w/#710087 DVD Player
710273	MP-1000 Passenger Safety Announcement Player w/4GB REI SD Card Motorcoach Safety Video	✓	✓
110416	BNC Female to RCA Male Adapter	✓	✓
511253	3' BNC Coax Cable - Male to Male	✓	✓
512612	DVD Audio Adapter Cable- Adds Dual RCA Male Inputs and Outputs to DVD Power/Audio Cable	✓	
511563	6' Power - 4 Pin Female Mini-Fit™ to Bare Wires	✓	✓
512352	3' Interface Cable - REI DVD Player to System 2000 Video Harness		✓
512487	18" Audio Cable - 4 Pin Male Mini-Fit™ to Dual Male RCA		
511885	3' Audio Cable - 4 Pin Female Mini-Fit™ to Dual Male RCA		
512192	4' Power Cable 12V - 2 Pin Female Mini-Fit™ to 4 Pin Female Mini-Fit™		
510564	3' RCA Cable - Dual Male to Male		
512355	3' Interface Cable - DVD Player (10 Pin Female Mini-Fit™) to RCA Audio Input/Output on MP-1000 Player		
512454	3' Audio Adapter Cable - MP-1000 Player to VR-3000 AM/FM/CD/DVD Stereo Radio		
510407	20' BNC Coax Cable - Male to Male		
511867	3' Power - MP-1000 Player (4 Pin Female Mini-Fit™) to DVD Player (4 Pin Female Mini-Fit™)		
512153	6' RCA Cable - Video and Stereo Audio (3x) Male to Male (Qty 2 - 1 for Audio / 1 for Video)		
110468	Adapter - BNC Male to RCA Female		
511653	or 25' RCA Cable - Dual Male to Male (Audio)		
510779	25' RCA Cable - Single Male to Male (Video)		
512686	Cable, In-Line Audio Blaupunkt DVD to MP-1000		
511389	25' RCA Cable - Dual Male to Female		
511397	15' RCA Cable - Single Male to Female		
511031	3' RCA Cable - Single Male to Female		

OPTIONAL

	PART #
20' Remote Play Button Cable - Round Push Button Style	511986
1' Remote Play Button Cable - Rocker Switch Style / 19' Rocker Switch Extension Cable	512673 512674
12/24V Power "Y" Cable 4 Pin Female Mini-Fit™ w/6" to Male Mini-Fit™ and 12" to Female Mini-Fit™ (Requires #511867)	512667
SD Card Adapter - Used to plug SD Card into USB Computer Port	690647

¹ Any system that does not use REI DVD player #710087, #710088, #710089

² Mounting MP-1000 in parcel rack

³ Mounting MP-1000 in dash

⁴ If system does not have #700887 distribution amp

⁵ If system has #700887 distribution amp

UMA Approved Motorcoach
Safety Video Included



SAFETY VIDEO WILL BE DISPLAYED
ON ALL MONITORS

- Customizable audio and video message
- Interfaces w/existing entertainment systems
- Auto-play, loop or start-stop playing
- Automatically switches between other video sources
- Playback date/time recorder for verifications
- Driver one-touch playback
- Includes 4GB REI SD card
- Rolling text message capability
- Durable, compact & lightweight

Elite System w/710089 DVD	Advanced Interim System w/710088 DVD	VR-3000 System	Generic System ¹	Blaupunkt In-dash DVD ²	Blaupunkt In-dash DVD ³
✓	✓	✓	✓	✓	✓
✓	✓	✓			
✓	✓				
	✓	✓ ⁴	✓	✓	✓
✓					
✓					
✓					
	✓				
		✓			
		✓			
		✓ ⁵			
			✓		
			Choose 1 Set of Cables Listed on Left Based on Length Needed		
				✓	✓
				✓	
				✓ (Qty 2)	
					✓



8" Subwoofer – Passive or Active

- 150 Watts max power
- Low profile for under seat mounting
- 15.25"L x 8.9"W x 2.7"H

ITEM	PART #
8" Subwoofer w/Built-in 12/24 Volt Amplifier	230067
8" Subwoofer Speaker – Passive	230066
Subwoofer w/National Mount	710518
Subwoofer w/Amaya Seatbelt Mount	710521
Subwoofer w/Standard Amaya Mount	710503

Subwoofer Cables

ITEM	PART #
42'/21' Dual Subwoofer Cable - 3 Pin Female Mini-Fit™ to Dual 3 Pin Female Mini-Fit™ taps Note: EC-750 Control Module to Subwoofer #1 (21') and Subwoofer #2 (42')	512723
Subwoofer "Y" Cable - 3 Pin Male Mini-Fit™ w/1' cable to Female Mini-Fit™ (subwoofer #1) and 1' to Male Mini-Fit™. Requires (1) 512614 to connect to Subwoofer #2 plus (1) 512614 connect to to EC-750 Driver Control Module or Audio Source Cable.	512614
20' Subwoofer Cable - 3 Pin Female Mini-Fit™ to 3 Pin Female Mini-Fit™ Note: EC-750 Control Module to Subwoofer	512624

play it.
hear it.
feel it.

4" One-Piece Speaker w/Grille

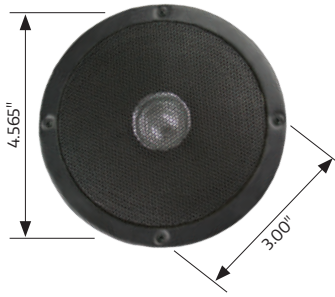

- Dual cone speaker
- 30 Watts max power
- 4 OHMS impedance

ITEM	PART #
4" One-Piece Speaker w/Grille	220078

5.25" Speaker w/Poly Cone

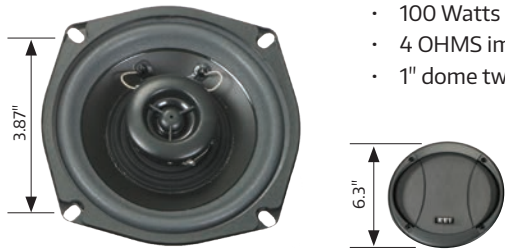

- 100 Watts max power
- 4 OHMS impedance
- 1" dome tweeter

ITEM	PART #
5.25" Speaker w/Poly Cone	220067
Grille	240060
Speaker and Grille	220094

6" Speaker w/0.5" Depth Grille

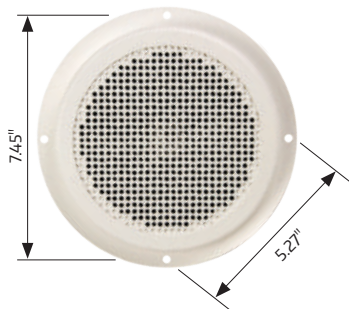

- 25 Watts max power
- 8 OHMS impedance
- Weather resistant

ITEM	PART #
6" Speaker w/0.5" Depth Grille	230052
Includes Harness w/2 Pin Weather Pack Plug	230053
Replacement Grille	240067

Coax Speakers

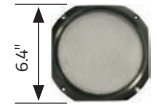
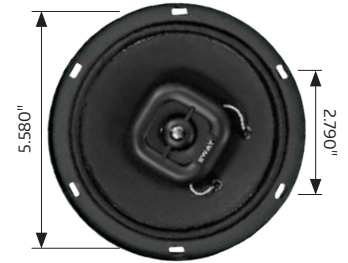

- 50 Watts max power
- 4 OHMS impedance
- Ferro-fluid cooled voice coil

ITEM	PART #
5.25" Coax Speaker	220049
Grille	240032

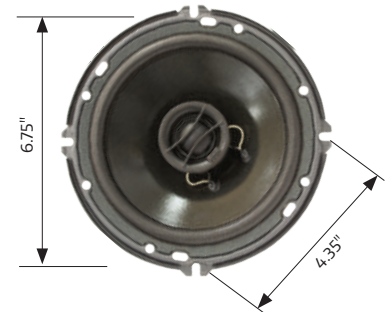

- 150 Watts max power
- 4 OHMS impedance
- Two-way coax

ITEM	PART #
6.75" Speaker	220096

speakers

4" Speakers

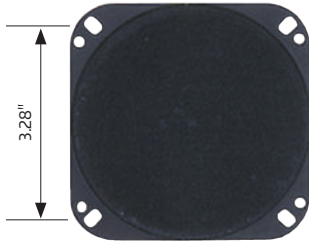

220040 ■ ■

- Full-range speaker
- 30 Watts max power
- 4 OHMS impedance

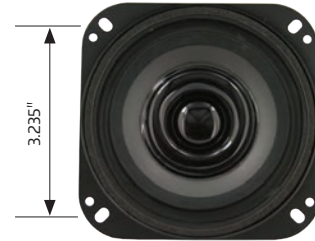

220010 ■ ■

- 25 Watts max power
- 4 OHMS impedance
- Poly speaker cone
- Solid mylar voice coil cap
- Butyl rubber surround

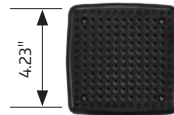

■ 240027

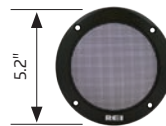

■ 240078

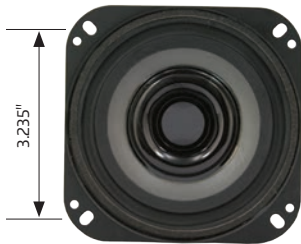

220089 ■ ■

- 25 Watts max power
- 8 OHMS impedance
- Poly speaker cone
- Solid mylar voice coil cap
- Butyl rubber surround
- Includes harness w/2 Pin Weather Pack connector

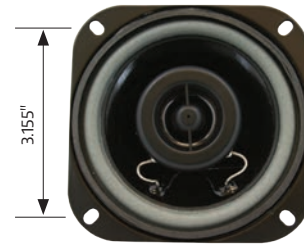

220062 ■

- 45 Watts max power
- 4 OHMS impedance
- 2 Pin harness plug
- 1" dome tweeter

ITEM	PART #
4" Speaker	220040
4" Weather Resistant Speaker	220010
4" Weather Resistant Speaker	220089
4" Coax Square Speaker	220062
■ Grille	240027
■ Grille	240078

ITEM	PART #
4" Coax Square Speaker w/Grille	231003

Includes:

4" Coax Square Speaker (220062) and Grille (240078)

5" Speakers

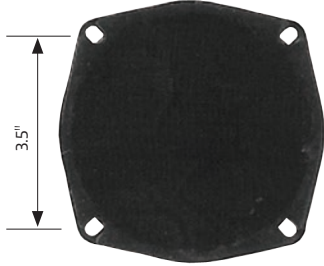

220035 ■

- Full-range speaker
- 30 Watts max power
- 4 OHMS impedance

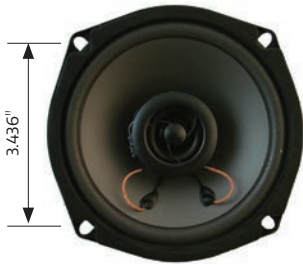

220073 ■

- Coax speaker design
- 70 Watts max power
- 4 OHMS impedance
- 1" dome tweeter

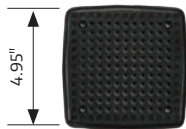

■ 240040

ITEM	PART #
5" Speaker	220035
5" Coax Speaker	220073
■ Grille	240040

Speakers with Grilles

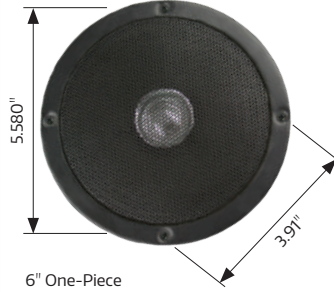

6" One-Piece

- Dual cone speaker
- 30 Watts max power
- 4 OHMS impedance

ITEM	PART #
6" One-Piece Speaker w/Grille	220026

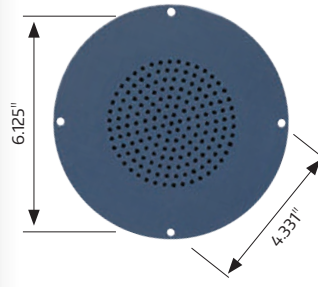

4" or 5" with 6.625" Gray Metal Grille

- 30 Watts max power
- 4 OHMS impedance

ITEM	PART #
4" Speaker	230011
5" Speaker	230002
4" Replacement Grille	240015
5" Replacement Grille	240011

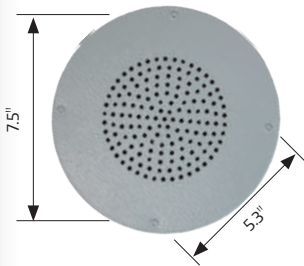

4" with 6.625" Aluminum Grille

- 25 Watts max power
- 8 OHMS impedance
- Weather resistant speaker cone
- Stud mounted

ITEM	PART #
4" Speaker w/6" Aluminum Grille	230065
Replacement Grille	240082

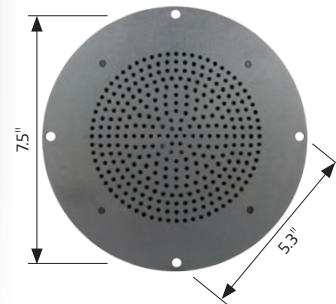

6" with 8" Aluminum Grille

- 25 Watts max power
- 8 OHMS impedance
- Weather resistant speaker cone

ITEM	PART #
6" Speaker Mounted on 8" Aluminum Grille	230061
Replacement Grille	240079

speakers

Speakers in Housings



- 4" coax speaker
- 45 Watts max power
- 4 OHMS impedance



- 5.42"W x 5.42"H x 4.3"D
- Coax speaker design
- 70 Watts max power
- Mounting bracket included



ITEM	PART #
4" Surface Mount Speaker in ABS Enclosure (Includes 2 Speakers)	760939

ITEM	PART #
5" Speaker Dual Cone (Includes 2 Speakers)	760663
5" Speaker Two-Way Coax (Includes 2 Speakers)	760622



- Metal housing

Includes:

- 2 grilles (240017)
- 18" dynamic cable (512679) 90° 4 Pin XLR Microphone Jack to 4 Pin Female Mini-Fit™

ITEM	PART #
4" Speaker/Grille and Integrated Microphone Jack (Includes 2 Speakers)	230072



- 4" 2-way coax speakers
- 120 Watts max power
- 4 OHMS impedance

ITEM	PART #
4" Speakers in Weatherproof Black Housings (WP-402BKH) (Includes 2 Speakers)	230073



- 4 OHMS impedance
- 15 Watts max power
- Adjustable mounting bracket

ITEM	PART #
3" Enclosed Speaker (Includes 2 Speakers)	230068

Exterior Speakers

Weather Resistant



4" Speaker w/Non-Louvered Aluminum Grille

- 6.5" x 4.75" grille
- 25 Watts max power
- 8 OHMS impedance
- Poly woofer cone
- Includes harness w/2 Pin Weather Pack connector



4" Speaker w/Louvered Aluminum Grille

- 6.5" x 4.75" grille
- 25 Watts max power
- 4 OHMS impedance
- Poly woofer cone



5" PA Horn

- 15 Watts max power
- Aluminum housing
- 8 OHMS impedance
- Adjustable mounting bracket



8" PA Horn

- 30 Watts max power
- 4 OHMS impedance
- Metal housing
- Adjustable mounting bracket

ITEM	PART #
4" Speaker w/Non-Louvered Aluminum Grille	230058
Replacement Grille	240076
4" Speaker w/Aluminum Grille	230049
Replacement Grille	240055
5" PA Horn	220022
8" PA Horn	220031PA

Speakers with Brackets



Dome Tweeter w/Mount Bracket

- 20 Watts max power
- 20 mm tweeter
- 92 dB SPL
- Silk dome tweeter

ITEM	PART #
Dome Tweeter w/Mount Bracket	231007
Dome Tweeter w/MCI Mount Bracket	231002



5.25" Speaker w/Bracket

- MCI E/J Coach
- 100 Watts max power
- Low profile 1" dome tweeter
- Includes harness w/2 Pin Mini-Fit™ connector

ITEM	PART #
5.25" Speaker w/Bracket	231010

antennas

Flexible AM/FM

Universal Mount Antenna



- Flexible, rust proof, wire wound mast w/rubber coating
- Split ball adjustable base w/included 60" antenna cable
- Male Motorola plug

ITEM	PART #
Flexible AM/FM Antenna w/60" Cable	210066
Flexible AM/FM Antenna w/82" Cable	210056
Flexible AM/FM Antenna w/192" Cable	210123
Replacement Rubber Mast	210067



- Flexible, rust-proof, wire wound mast w/rubber coating
- Split ball adjustable base
- 3 hole surface mount
- Male Motorola plug
- Requires 23' cable
 - Heavy duty shielded cable jacket
 - Grounding strap

ITEM	PART #
Flexible AM/FM Universal Mount Antenna	210081
23' Cable	530060

Telescoping Antennas



- 96" 4 section telescoping steel mast
- Dual mounting points
- Includes 96" antenna cable
- Male Motorola plug

ITEM	PART #
AM/FM Steel Mast Telescoping Antenna	210000



- Pillar mount

ITEM	PART #
Telescoping Antenna w/48" Cable	210018

AM/FM Top/Side

Universal Mount Antenna

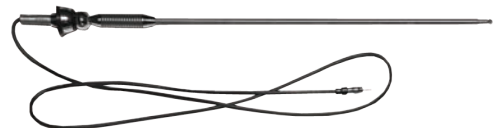

- Single section 31" steel mast
- Universal top or side mount/heavy-duty spring
- Includes 54" antenna cable
- Mast adjustable to 180°
- Male Motorola plug

ITEM	PART #
AM/FM Top/Side Universal Mount Antenna	210098

AM/FM Steel Mast

Side Mount Antenna



- Single section 31" steel mast
- Side mount/heavy-duty spring
- Includes 54" detachable antenna cable
- Male Motorola plug

ITEM	PART #
AM/FM Steel Mast Side Mount Antenna	210015
Replacement Mast	210137

AM/FM Shark Fin Antenna

Antenna & Cable



ITEM	PART #
Antenna, Shark Fin AM/FM with Integrated Amplifier	210145

Note: 530170 or 530171 power cable required.



530171, 530170

ITEM	PART #
36" Shark Fin Integrated Antenna/ Power Cable, Shark Fin Antenna to Radio (Motorola Male and 12 Volt Power Wire)	530171
276" Shark Fin Integrated Antenna/ Power Cable, Shark Fin Antenna to Radio (Motorola Male and 12 Volt Power Wire)	530170

AM/FM Silver GM Antenna

(1982-Up)



- 31" steel mast
- Universal base w/5 fixed angle pieces
- Includes 72" antenna cable
- Male Motorola plug

ITEM	PART #
AM/FM Silver GM Antenna (1982-Up)	210131

AM/FM Dodge Full-Size Van Antenna

(1995-Up)



- 39" 3 section mast
- Side mount base
- Includes 60" detachable antenna cable
- Male Motorola plug

ITEM	PART #
AM/FM Dodge Full-Size Van Antenna (1995-Up)	210128

AM/FM Ford Econoline Van Antenna

(1979-Up)



- 31" steel mast
- Oval base antenna
- Includes 72" antenna cable
- Male Motorola plug

ITEM	PART #
AM/FM Ford Econoline Van Antenna (1979-Up)	210127

antennas

AM/FM Amp. Dodge/Mercedes

Sprinter Van Antenna



- Includes 15" black removable fiberglass mast
- Includes 12" coax cable and power supply wire
- Male Motorola plug

ITEM	PART #
AM/FM Amplified Dodge/Mercedes Sprinter Van Antenna	210129

Antenna Extension Cables

Motorola Female to Motorola Male Plugs

ITEM	PART #
24" Extension Cable	530013
36" Extension Cable	530015
48" Extension Cable	530001
60" Extension Cable	530043
96" Extension Cable	530003
144" Extension Cable	530004
240" Extension Cable	530044

CB Antenna



- 26.965 MHz frequency
- CB band 11 meter channels 1-40
- Single section spring loaded 14" mast
- Oval base
- PL259 connector
- Male Motorola plug
- Requires 21' cable
 - Heavy-duty shielded cable jacket
 - PL259 connectors
 - N connector adapter

ITEM	PART #
CB Antenna	210108
21' Cable	511132

FM Signal Booster



- Amplifies FM signal an average of 8 times
- Improves radio reception
- Extends station range
- 2 Volts maximum total input
- Male Motorola plug

ITEM	PART #
FM Signal Booster	210103

mobile cellular wi-fi routers









REI's mobile cellular routers are specialized for transportation providers with thousands of users on buses, trains and other vehicles. We know that our customers depend on quick installation and affordability. Whether you're using a laptop, tablet, or other handheld devices, you'll get reliable Internet access just about anywhere.



All Wi-Fi Routers Include:

- 4G modem
- External power, status and signal strength indicators
- Dual Ethernet ports for device connectivity
- Connection for external cellular antennas
- 12V power conditioning module and cables
- 3 year warranty

Carrier	Wi-Fi Router
Sprint 4G	832178
Verizon 4G	832172
AT&T 4G	832176

- Internet 
- Music 
- Games 
- Email 
- Videos 
- Social Networking 



Cellular Antenna

	PART #
Magnetic Mount Low Profile Cellular Antenna – SMA Connector (2 required)	210133
Glass Mount Cellular Antenna – SMA Connector (2 required)	210134
NMO Low Profile Antenna w/17' Cable (2 required)	210136
NMO Low Profile Antenna w/17' Cable Thick Mount (2 required)	210152
3G/4G Cellular Antenna Direct 20' (1 required)	210150
NMO Dual Wi-Fi 2.4/5Ghz and (2) 20' Cables with RP-SMA Male Connectors	210149
NMO Dual Wi-Fi 2.4/5Ghz Dual 4G LTE and (2) 20' Cables with RP-SMA Connectors (Wi-Fi) and (2) 20' Cables w/SMA Male Connectors (cellular)	210151



Mounting Kit

	PART #
Metal Router Housing w/Power Filter	551033

Note: For surface wallmount of router or can be mounted onto REI DVR lock box.

Additional services available. Call REI for details.

REI's individual passenger headphone systems have a rugged, dependable audio control module, free of moving parts. Engineered using the latest technology, they provide clean, high fidelity stereo signals at every seat.

Passengers simply plug in their headphones and choose from a variety of sources: AM/FM CD players, SAT radio, DVD, digital video and digital audio players. All channels feature PA override for driver and tour guide announcements.

- Up to 8 stereo channel capability
- Digital LED channel display
- Durable soft-touch controls with wear-resistant overlay
- Individual volume control
- 3.5mm stereo headphone jack
- All electronic switching (no moving parts)
- Headphone amp is overload and short circuit protected
- Compact size: 1/2" recessed depth (1" Overall), 2" height, 5" width
- Components and cables selected for sound quality and reliability

Audio Entertainment

The REI passenger headphone system provides the ultimate listening experience. This digital seat back audio system gives customers the choice of up to eight high-fidelity stereo channels. Each passenger has independent headphone volume control. Whether listening to audio from the REI video system, enjoying an audio book on CD or relaxing to the sounds of digital music, passengers will love the freedom to choose. Customers who prefer to read or sleep while traveling will be able to enjoy the experience without interruptions from the interior speaker systems. Once customers experience the personal entertainment provided by the REI headphone audio system, they will no longer be satisfied with single audio option systems.

Seat Back Audio Module



- 1-8 channel capability
- Digital LED channel display
- Individual volume control
- Tamper-resistant design
- 3.5mm headphone jack
- 0.5" seat mounting depth

ITEM	PART #
Seat Back Audio Module	700741

individual passenger seat back audio

Multi-Lingual Tour Capabilities

With the number of foreign tourists increasing, it is a necessity to provide tour announcements and narration in several languages. The combination of the REI passenger headphone system and REI 8 channel digital MP3 audio player is the ultimate way to provide multi-lingual tours. Record tour and stop information in up to eight different languages and provide all of your passengers with the same information. This user-friendly system provides each customer with a choice of languages on their seat back audio module. Upon arriving at each tour stop, the driver initiates the playback of pre-recorded messages in all languages simultaneously.

Seat audio system bill of material depends on type of vehicle, seat configuration and desired features. Contact your REI representative for assistance.

30mm Stereo Headphone



- 46" cable w/right angle 3.5mm plug
- Adjustable headband w/rotating earpads
- 32 OHMS impedance

ITEM	PART #
30mm Stereo Headphone	480282

8 Channel Digital Audio Player

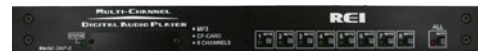

- 12 Volt
- Plays 8 independent channels of audio simultaneously
- Audio stored on CF-Card
- Great for multi-lingual audio

ITEM	PART #
8 Channel Digital Audio Player	710076

individual passenger seat back audio

Pre-Recorded Tour Narration

Provide customers the perfect customized tour every time by adding an REI digital audio/video player to the seat back audio system. Eliminate inconsistent, inaccurate and boring tours. Simply record specific tour information for each point of interest on a compact flash card, install the machine on the bus, make a few wiring connections and the system is ready. A control panel mounted next to the driver is used to operate the system. Upon arriving at each point of interest, the driver simply pushes a button to initiate the narration for that sight. The system is also capable of being automatically triggered based on GPS coordinates eliminating the need for manual control. Multiple buses conducting the same tour simply use copies of the compact flash card and customers get the perfect tour every time. Include advertising messages between tour stops to increase revenue and profits. Eliminate the need for an on-site host or tour guide. Improve passenger perception of the attraction, city or event.

8 Channel Stereo Line Amp



- Independent audio output level adjustment for up to 8 channels
- LED VU meters for level setting
- Power switch controls power to seat audio units
- 24 Volt DC for low current consumption
- Low harmonic distortion
- PA override capability
- Drive capability of over 100 seat audio units
- Dual output connections for easier installation

ITEM	PART #
24 Volt 8 Channel Stereo Line Amplifier	700732
12 Volt 8 Channel Stereo Line Amplifier	700710

Audio Processor Module

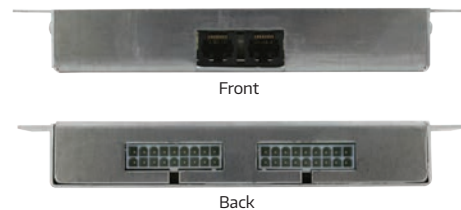

- Provides channel selection and volume control for 2 seat back audio modules
- Low mounting profile for underseat mounting
- Rugged Mini-Fit™ connector system
- Available in a 3, 5 or 8 channel version
- Integrated headphone amp w/overload and short circuit protection
- Polyswitch fuse protection

ITEM	PART #
8 Channel Audio Processor	700742
5 Channel Audio Processor	700758
3 Channel Audio Processor	710463

Tour Narration

The REI passenger headphone system is perfect for tour narration. With digital seat back audio modules supplying crisp, clear stereo signals, customers will hear the tour guide or driver without interruption. Each passenger controls the volume from their headphones independently. No more disturbing road noise or customers complaining they cannot hear. Passengers are sure to have the most enjoyable and memorable tour experience ever. Many companies have expanded their tours to include music entertainment between each tour stop. With REI audio systems, the possibilities are limitless.

Seat Audio Source Cabinet

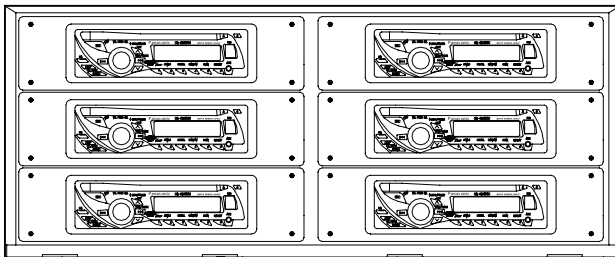

- Modular design
- Holds up to 6 AM/FM/CD radios
- Locking door optional
- Master reset
- Power indicators
- Universal mounting
- Provides conditioned, isolated audio sources to line amplifier
- 24 Volt or 12 Volt versions
- 24" L x 13" W x 10" H

ITEM	PART #
Seat Audio Source Cabinet	Contact REI
Seat Audio Source Cabinet for Sony AM/FM/CD/ HD Stereo Radio – Satellite Radio Ready	710431

video system service parts

Elite System



Control Module



CD-5000

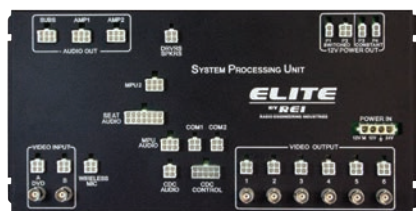

System Processing Unit



DVD Player



Amplifier

ITEM	PART #
Control Module	700819
System Processing Unit	700855
Amplifier	700905
EVR-6500D – Elite	710464
CD-5000 – Elite	710493
10" USB Weather Resistant Panel Mount w/Cover to Male USB Connector	512485
Pioneer AM/FM/CD – Elite	710412
8 Channel A/V Expansion Module	710011
Video B Node Box	710100
DVD Player – Elite	710089

Pioneer XM Satellite Accessories

Compatible with Elite System, System 2000 and Advanced System.

ITEM	PART #
Pioneer XM Tuner*	710285
Pioneer Magnetic XM Antenna*	210126
Pioneer XM Tuner/Radio Cable*	512356

*Required when using satellite service.

System 2000



Control Module



DVD Player



Amplifier 3000

ITEM	PART #
Digital Control Module – 24V	700227
Digital Control Module – 12V	700285
Amp 3000, 150 Watt x 2	700771
Amp 3000, Limited Gain – 25 Watt x 2	700799
Amp, 2 Channel – 12V	710488
CD-5000 – System 2000	710496
10" USB Weather Resistant Panel Mount w/Cover to Male USB Connector	512485
Pioneer AM/FM/CD – System 2000	710416
DVD Player – System 2000	710087

750080 adapter cable required if replacing 700511 or 700189 amplifiers w/these models.

Advanced System



Control Module



DVD Player



5 Channel Audio Amplifier

ITEM	PART #
Control Module (710232)	Call REI
5 Channel Audio Amplifier	700537
CD-5000 – Advanced System	710493
Pioneer AM/FM/CD – Advanced System	710414
DVD Player – Advanced System	710088

REI

6534 L Street
Omaha, NE 68117

800.228.9275
402.339.2200

radioeng.com

